

DAEWOO

Service Manual

XGA COLOR MONITOR

Model : 531X

Warning

The data contained within this manual may not reflect your configuration. Please verify this information matches your model before making repairs. For Daewoo technical support call 1-800-245-9870.

DAEWOO ELECTRONICS CO., LTD.

<http://svc.dwe.co.kr>

September, 2000

CONTENTS

SAFETY PRECAUTIONS	1
GENERAL SAFETY INFORMATION	2
SERVICING PRECAUTIONS	3
TECHNICAL INFORMATION	6
GENERAL INFORMATION	7
PIN CONNECTOR	8
CAUTIONS FOR ADJUSTMENT AND REPAIR	8
OPERATION AND ADJUSTMENT	9
ALIGNMENT PROCEDURE	12
TROUBLESHOOTING HINTS	15
BLOCK DIAGRAM	29
PCB LAYOUT	30
SCHEMATIC DIAGRAM	33
EXPLODED VIEW DIAGRAM	37
INFORMATION OF PART DESCRIPTION	38
ELECTRICAL PARTS LIST	39

SAFETY PRECAUTIONS

CAUTION: No modifications of any circuits should be attempted. Service work should be performed only after you are thoroughly familiar with all of the following safety checks and servicing guidelines.

◆ Safety Check

Care should be taken while servicing this analog color display because of the high voltages used in the deflection circuits. These voltages are exposed in such areas as the associated flyback and yoke circuits.

◆ Fire & Shock Hazard

- Insert an isolation transformer between the analog color display and AC power line before servicing the chassis.
- When servicing, pay close attention to the original lead dress especially in the high voltage circuit area; if a short circuit is found, replace all parts which have been overheated as a result of the short circuit.
- All the protective devices must be reinstalled per original design.
- Soldering must be inspected for possible cold solder points, frayed leads, damaged insulation, solder splashes or sharp solder points. Be certain to remove all foreign materials.

◆ Implosion Protection

Picture tube in this monitor employs integral implosion protection system, but care should be taken to avoid damage and scratching during installation.

Only use same type replacement picture tubes.

IMPORTANT SAFETY NOTICE: There are special components used in this analog color display, which are important for safety. These parts are shaded on the schematic diagram and on the replacement parts list. It is essential that these critical parts should be replaced with manufacturer's specified parts to prevent X-Ray, shock, fire or other hazards. Do not modify the original design without getting written permission from DAEWOO ELECTRONICS CO. or this will void the original parts and labor warranty.

◆ X-Ray

WARNING: The only potential source of X-Ray is the picture tube. However when the high voltage circuitry is operating properly, there is no possibility of an X-Ray problem. The basic precaution which must be exercised is to keep the high voltage at the following factory recommended level.

NOTE: It is important to use an accurate, periodically, calibrated high voltage meter.

- To measure the high voltage, use a high-impedance high-voltage meter.
Connect(-) to chassis and (+) to the CRT anode button.
- Turn the Contrast & Brightness Control fully counterclockwise.
- Measure the high voltage. The high voltage meter should indicate the following factory recommended levels.
- If the upper meter indication exceeds the maximum level, immediate service is required to prevent the possibility of premature component failure.
- To prevent X-Ray possibility, it is essential to use the specified picture tube.
- The normal high voltage is 25.5KV or below and must not exceed 29KV at zero beam current at rated voltage.

GENERAL SAFETY INFORMATION

◆ Terms in the manual

- CAUTION Statements identify conditions or practices that could result in damage to the equipment or other property.
- WARNING Statements identify conditions or practices that could result in personal injury or loss of life.

◆ Terms as marked on equipment

- CAUTION Statements indicate a personal injury hazard not immediately accessible as one reads the marking or a hazard which is properly included on the equipment itself.
- WARNING Statements are clearly concerning indicated personal injury hazards.

◆ Symbols in the manual

The symbols indicate where applicable cautionary or other information is to be found.

◆ Symbols as marked on equipment

Protective GROUND terminal



◆ High Voltage Warning And Critical Component Warning Label

The following warning label is on the CRT PWB shield case inside the unit.

Warning: This product includes critical mechanical and electrical parts which are essential for x ray protection. For continued safety, replace critical components that are indicated in the service manual with exact replacement parts given in the parts list.
Operating high voltage with this product is 29Kv at minimum brightness. Refer to service manual for measurement procedures and proper service adjustments.

SERVICING PRECAUTIONS

CAUTION: Before servicing instruments covered by this service manual, its supplements, and addendum, please read and follow the SAFETY PRECAUTIONS of this manual.

NOTE: If unforeseen circumstances create conflict between the following servicing precautions and any of the safety precautions on page 1 of this manual, always follow the safety precautions. Remember: Safety First.

◆ General Servicing Precautions

1. Always unplug the AC power cord from the AC power source before:
 - a. Removing or reinstalling any component, circuit board, module, or any other instrument assembly.
 - b. Disconnecting or reconnecting any electrical plug or other electrical connection.
 - c. Connecting a test substitute in parallel with an electrolytic capacitor in the instrument.

CAUTION: A wrong part substitution or incorrect polarity installation of electrolytic capacitors may result in a explosion.

- d. Discharging the picture tube anode.
2. Test high voltage only by measuring it with an appropriate high voltage meter or other voltage measuring device (DVM, FETVOM. etc.) equipped with a suitable high voltage probe. Do not test high voltage by “drawing an arc”.
3. Discharge the picture tube anode only by: (a) first connecting one end of an insulated clip lead to the degaussing or line grounding system shield at the point where the picture tube socket ground lead is connected, and then (b) touching the other end of the insulated clip lead to the picture tube anode button, using an insulating handle to avoid personal contact with high voltage.
4. Do not any spray chemicals on or near this instrument, or any of its assemblies.
5. Unless otherwise specified in this service manual, only clean electrical contacts by applying the following mixture to the contacts with a pipe cleaner, cotton-tipped stick, or comparable nonabrasive applicator: 10% (by volume) Aceton and 90% (by volume) isopropyl alchohol (90%-99% strength).

CAUTION: This is a flammable mixture. Unless specified in this service manual, lubrication of contacts is not required.

6. Do not damage any plug/socket B+ voltage interlocks with which instruments covered by this service manual might be equipped.
7. Do not apply AC power to this instrument and/or any other of its electrical assemblies unless all the solid-state device heat sinks are correctly installed.
8. Always connect the test instrument ground lead to the appropriate instrument chassis ground before connecting the test instrument positive lead. Always remove the test instrument ground lead last.
9. Only use the test fixtures specified in this service manual with this instrument.

CAUTION: Do not connect the test fixture ground strap to any heatsink in this instrument.

◆ Electrostatically Sensitive (ES) Devices

Some semiconductor (solid state) devices can be damaged easily by static electricity. Such components are commonly called Electrostatically Sensitive (ES) Devices. The typical examples of ES devices are integrated circuits, some field-effect transistors, and semiconductor “chip” components. The following techniques should be used to help reduce the incidence of component damage caused by static electricity.

1. Immediately before handling any semiconductor component or semiconductor-equipped assembly, wipe off any electrostatic charge on your body by touching any known earth ground. Alternatively, obtain and wear a commercially available discharging wrist strap device which should be removed for potential shock reasons prior to applying power to the unit under testing conditions.
2. After removing the electrical assembly equipped with ES devices, place the assembly on a conductive surface such as aluminum foil to prevent electrostatic charge buildup or exposure to the assembly.
3. Only use a grounded-tip soldering iron to solder or unsolder ES devices.
4. Only use an anti-static type solder removal device. Some solder removal devices not classified as “anti-static” can generate enough electrical charges to damage ES devices.
5. Do not use freon-propelled chemicals. These can generate enough electrical charges to damage ES devices.
6. Do not remove a replacement ES device from its protective package until immediately before you are ready to install it. (Most replacement ES devices are packaged with leads electrically shorted together by conductive foam, aluminum foil, or comparable conductive material).
7. Immediately before removing the protective material from the leads of replacement ES devices, touch the protective material to the chassis or circuit assembly into which the device will be installed.

<p>CAUTION: Be sure that no power is applied to the chassis or circuit, and observe all other safety precautions.</p>
--

8. Minimize bodily movements when handling unpackaged replacement ES devices. (Otherwise harmful motion such as the brushing together clothes fabric or the lifting your foot from a carpeted floor can generate enough static electricity to damage ES devices).

◆ General Soldering Guidelines

1. Use a grounded-tip, low-wattage soldering iron with appropriate tip size and shape that will maintain tip temperature between a 550°F-660°F (288°C-316°C) range.
2. Use an appropriate gauge of RMA resin-core solder composed of 60 parts tin/40 parts lead.
3. Keep the soldering iron tip clean.
4. Thoroughly clean the surface to be soldered. Use a small wire-bristle (0.5 inch or 1.25cm) brush with a metal handle. Do not use freon-propelled spray-on cleaners.
5. Use the following soldering technique:
 - a. Allow the soldering iron tip to reach normal temperature (550°F to 660°F or 288°C to 316°C)
 - b. Hold the soldering iron tip and solder strand against the component lead until the solder melts.
 - c. Quickly move the soldering iron tip to the junction of the component lead and the printed circuit foil, and hold it there until the solder flows onto and around both the component lead and the foil.
 - d. Closely inspect the solder area and remove any excess or splashed solder with a small wire-bristle brush.

<p>CAUTION: Work quickly to avoid overheating the circuit board printed foil.</p>
--

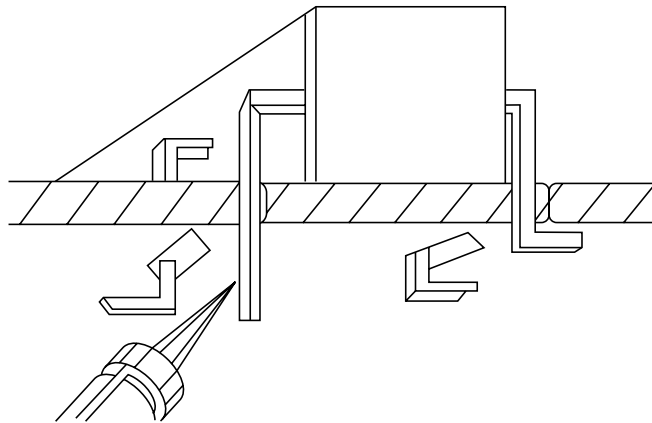

FIGURE 1. USE SOLDERING IRON TO PRY LEADS

◆ IC Removal/Replacement

Some utilized chassis circuit boards have slotted (oblong) holes through which the IC leads are inserted and then bent flat against the circuit foil. When holes are slotted, the following technique should be used to remove and replace the IC. When working with boards using the familiar round hole, use the standard technique as outlined in paragraphs 5 on the page under the title of general soldering guidelines.

◆ Removal

1. Desolder and straighten each IC lead in one operation by gently prying up on the lead with the soldering iron tip as the solder melts.
2. Draw away the melted solder with an anti-static suction-type solder removal device (or with desoldering braid before removing the IC).

◆ Replacement

1. Carefully insert the replacement IC in the circuit board.
2. Carefully bend each IC lead against the circuit foil pad and solder it.
3. Clean the soldered areas with a small wire-bristle brush. (It is not necessary to reapply acrylic coating to the area).

◆ “Small-Signal” Discrete Transistor Removal/Replacement

1. Remove the defective transistor by clipping its leads as close as possible to the component body.
2. Bend the ends of each of three leads remaining on the circuit board into a “U” shape.
3. Bend the replacement transistor leads into a “U” shape.
4. Connect the replacement transistor leads to the corresponding leads extending from the circuit board and crimp the “U” with long nose pliers to ensure metal-to-metal contact, then solder each connection.

◆ Power IC, Transistor or Devices Removal/Replacement

1. Heat and remove all solders from the device leads.
2. Remove the heatsink mounting screw (if applicable).
3. Carefully remove the device from the circuit board.
4. Insert new device in circuit board.
5. Solder each device lead and then clip off excess lead.
6. Replace heatsink.

◆ Diode Removal/Replacement

1. Remove defective diode by clipping its leads as close as possible to diode body.
2. Bend the two remaining leads perpendicularly to the circuit board.
3. Observing diode polarity, wrap each lead out of the new diode around the corresponding lead on the circuit board.
4. Securely crimp each connection and solder it.
5. Inspect the solder joints of the two “original” leads on the circuit board copper side. If they are not shiny, reheat them and apply additional solder if necessary.

TECHNICAL INFORMATION

CDT Size		15-inch
Diagonal visible image area		14-inch
Dot Pitch		0.28 mm
Synchronization	Horizontal	30 - 54 KHz
	Vertical	50 - 160 Hz
Plug and Play		DDC1/2B/CI
Power Saving		EPA, VESA DPMS, Nutek Compliant
Power Source		100-240 Vac, 50/60Hz (Free Voltage)
Power Consumption		70W
Dimension-W x H x D (set with stand)		360 x 377 x 389mm
Weight-unpacked(lbs/Kg)		25.4/11.5
Operating Temperature		10 ~ 40°C /50 ~ 104°F

GENERAL INFORMATION

This color monitor automatically scans all horizontal frequencies from 30KHz to 54KHz, and all vertical frequencies from 50Hz to 160Hz. This color monitor supports IBM PC, PC/XT, PC/AT, personal System/2 (PS/2), Apple Macintosh, and compatible users crisp text and vivid color graphics display when using the following graphics adapters : (VGA, 8514/A, Super VGA, VESA and XGA and Apple Macintosh Video Card). And so, this color monitor has a maximum horizontal resolution of 1024 dots and a maximum vertical resolution of 768 lines for superior clarity of display.

By accepting analog signal inputs which level is zero to 0.7 Volts. This color monitor can display an unlimited palette of colors depending on the graphics adapter and software being used.

◆ Abbreviations

ADJ	Adjustment
AFC	Automatic Frequency Control
CRT	Cathode Ray Tube
Def	Deflection
D.Y	Deflection Yoke
FBT	Flyback Transformer
H.SYNC	Horizontal Synchronization
OSC	Oscillator
P.S.U	Power Supply Unit
PWA	Printed Circuit Board Wiring Assembly
R.G.B	Red, Green, Blue
V.Sync	Vertical Synchronization

PIN CONNECTOR

Pin	Signal
1	Red
2	Green
3	Blue
4	GND
5	GND
6	GND - Red
7	GND - Green
8	GND - Blue
9	+5Vdc
10	GND - H.Sync
11	GND - V.Sync
12	Bi-directional Data (SDA)
13	Horizontal Sync
14	Vertical Sync (VCLK)
15	Data Clock (SCL)

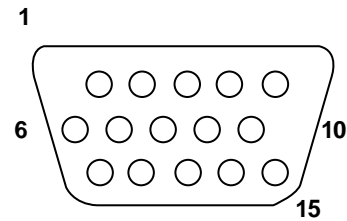

Arrangement of 15-pin D-sub connector

CAUTIONS FOR ADJUSTMENT AND REPAIR

- Degaussing is always required when adjusting purity or convergence.
- The white balance adjustment has been done by a color analyzer in factory. The adjustment procedure, described in the service manual is made by a visual check.
- Allow 20 minutes warm-up time for the display before checking or adjusting only electrical specification or function.
- Reform the leadwire after any repair work.

◆ Caution For Servicing

- In case of servicing or replacing CRT, high voltage sometimes remains in the anode of the CRT. Completely discharge high voltage before servicing or replacing CRT to prevent a shock to the serviceman.

OPERATION AND ADJUSTMENT

Control Panel

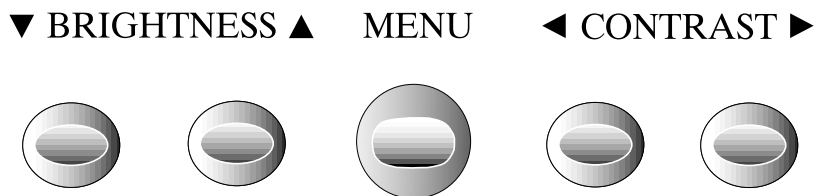

- Move cursor to the right window on the OSD window.
- Increase the value of any selected function.



- Move cursor to the left window on the OSD window.
- Decrease the value of any selected function.



- Launch OSD(On-Screen Display) MENU window.



- Move cursor to the high window on the OSD window.
- Increase the value of V.size or V.center.







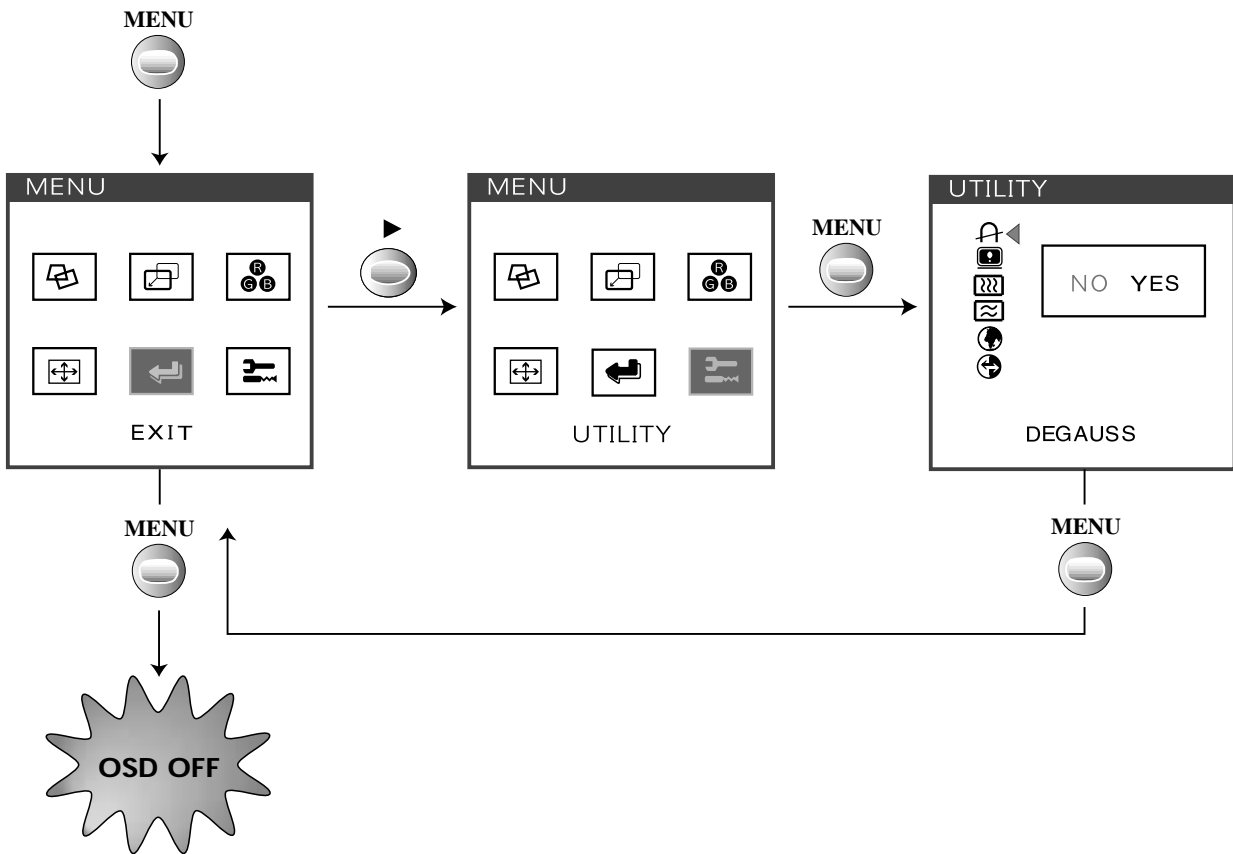









- Move cursor to the low window on the OSD window.
- Decrease the value of V.size or V.center.

Key Process







- When you choose the icon  on the OSD window, you can exit the OSD screen.

OSD Functions

ICON	CONTROL	FUNCTIONS
	PINCUSHION	Adjust the left and right margins for more convex or more concave margins.
	TRAPEZOID	Adjust the trapezoid of the screen by moving the lines inward or outward.
	PARALLELOGRAM	Adjust the parallelogram when the screen is leaning left or right.
	PIN BALANCE	Adjust the side balance when the sides of the screen are bowed towards left or right.
	T. PIN CORNER	Adjust the pin corner top when the top sides of the screen are bowed.
	B. PIN CORNER	Adjust the pin corner bottom when the bottom sides of the screen are bowed.
	H. CENTER & V. CENTER	Adjust the position of the display horizontally (left or right) and vertically (up or down).
	COLOR TEMP	Choose different preset color temperatures or set your own customized color parameters.
	RED GAIN	Adjust the red gain.
	GREEN GAIN	Adjust the green gain.
	BLUE GAIN	Adjust the blue gain.
	H. SIZE & V. SIZE	Adjust the width (horizontal size) and the height (vertical size) of the display.
	DEGAUSS	Degaussing keeps the monitor free from unwanted magnetism that can result in color impurity.
	STATUS	Display horizontal & vertical frequency and polarity.



ICON	CONTROL	FUNCTIONS
	H. MOIRE	Adjust the horizontal picture moire cancellation.
	V. MOIRE	Adjust the vertical picture moire cancellation.
	LANGUAGE	Select language for OSD (5 languages).
	RECALL	Reset the screen to the Factory Preset Display Settings.

ALIGNMENT PROCEDURE

◆ Standard Adjustment Conditions

1. Power source voltage : 100-240Vac 50/60Hz
2. Aging : Take at least 20 minutes warm-up time.
3. Signals
 - Video : Analog 0.7Vpp 75Ω terminal positive polarity
 - Synchronizing : TTL level Negative/Positive Separate
 - Deflection frequency
 - Horizontal Frequency : 30KHz - 54KHz
 - Vertical Frequency : 50Hz - 160Hz

◆ Pre-Adjustment

1. B+ Adjustment
 - Adjust 50Vdc \pm 0.1Vdc between D102 cathode and ground at 31.5KHz mode, varying VR001.
 - Adjust 59Vdc \pm 0.1Vdc between D510 cathode and ground at 31.5KHz mode, varying VR501.

◆ Method to launch the factory mode

- Step 1. Push the menu button.
- Step 2. Push the menu button and plus control button (▼) for 5 times in same time.

◆ Main Adjustment

1. Setting the Controls
 - Set the value of items as following.
 - Contrast : Max.(OSD value up to MAX)
 - Brightness : Center(Set the OSD value to center)
2. H.size, V.size, H.center, V.center, Pin Balance, Pincushion, Trapezoid
 - Receive the cross hatch pattern of Factory preset mode.
 - H.size, V.size, H.center, V.center, Pin Balance, Pincushion, Trapezoid are adjusted at each mode.
 - In Factory, Auto Alignment was done at each mode. Therefore, Factory preset mode has it's own value according to each control.
3. Focus
 - (a) Set brightness control to center and contrast control to MAX.
 - (b) Receive all "H" character pattern of 1024 X 768 (48KHz, 60Hz)
 - (c) Adjust the Focus control of FBT to obtain best Focus.
4. Geometric Distortion Adjustment.
 - (a) Receive the cross hatch pattern of factory preset mode.
 - (b) Pincushion, Trapezoid, Pin Balance are adjusted the best geometric status.
5. White Balance Adjustment
 - (a) Select 9300°K on the OSD Menu.
 - (b) Receive a full white pattern of 54KHz mode signal by using the signal generator.
 - (c) Set the brightness control to the maximum, the contrast control to the maximum.
 - (d) Cut off the FBT screen VR.
 - (e) Receive all the black patterns. The luminance of the screen should be 0.5~1.0 Ft-L by using Screen VR.
 - (f) Select the R-BIAS, G-BIAS and B-BIAS on the control menu and adjust the +/- key to get the color coordinates in $x=0.281 \pm 0.015$, $y=0.311 \pm 0.015$.
 - (g) Receive a full white pattern. Adjust the brightness value to the center.
 - (h) Select the R-GAIN and B-GAIN and adjust the +/- key to get the color coordinates in $x=0.281 \pm 0.015$, $y=0.311 \pm 0.015$.
 - (i) Adjust the ABL control to get the screen luminance to 30 Ft/L (a full white pattern over 30 Ft/L)
 - (j) Check if the x, y coordinates of color analyzer is in $x=0.281 \pm 0.015$, $y=0.311 \pm 0.015$.
If the color coordinates is out of range, adjust the R. G. B BIAS & GAIN to get the coordinates in $x=0.281$, $y=0.311$. Make sure that the coordinates is in range.
 - (k) Select 6550°K on the OSD Menu and set the color coordinates in $x=0.313$, $y=0.329$ at the maximum contrast control and center brightness control
 - (l) Check if a full white pattern is over 30Ft/L.

6. Static Convergence Adjustment

- (a) Apply a magenta cross hatch pattern on display.
- (b) Adjust the focus from the best over all focus on the display.
Also adjust the brightness to the desired condition.
- (c) Vertical red and blue lines are converged by varying the angle between the two tabs of the 4-pole magnets.
- (d) Horizontal red and blue lines are converged by varying the tabs together, keeping the angle between them constant.
- (e) Apply a yellow cross hatch pattern on display.
- (f) Vertical green and red lines are converged by varying the angle between the two tabs of the 6-pole magnets.
- (g) Horizontal green and red lines are converged by varying the tabs together, keeping the angle between them constant.

TROUBLESHOOTING HINTS

1. No Character

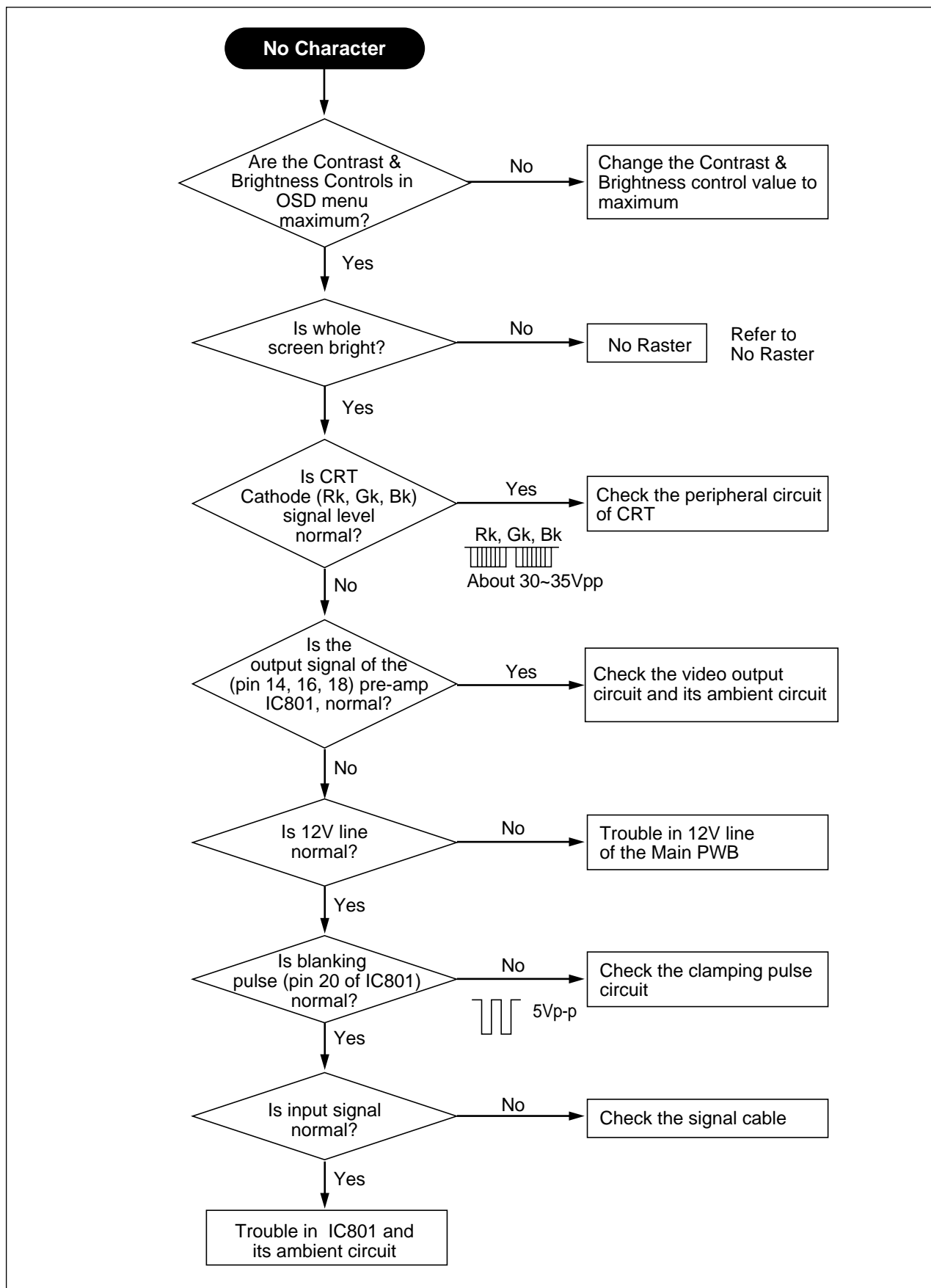

2. No Raster

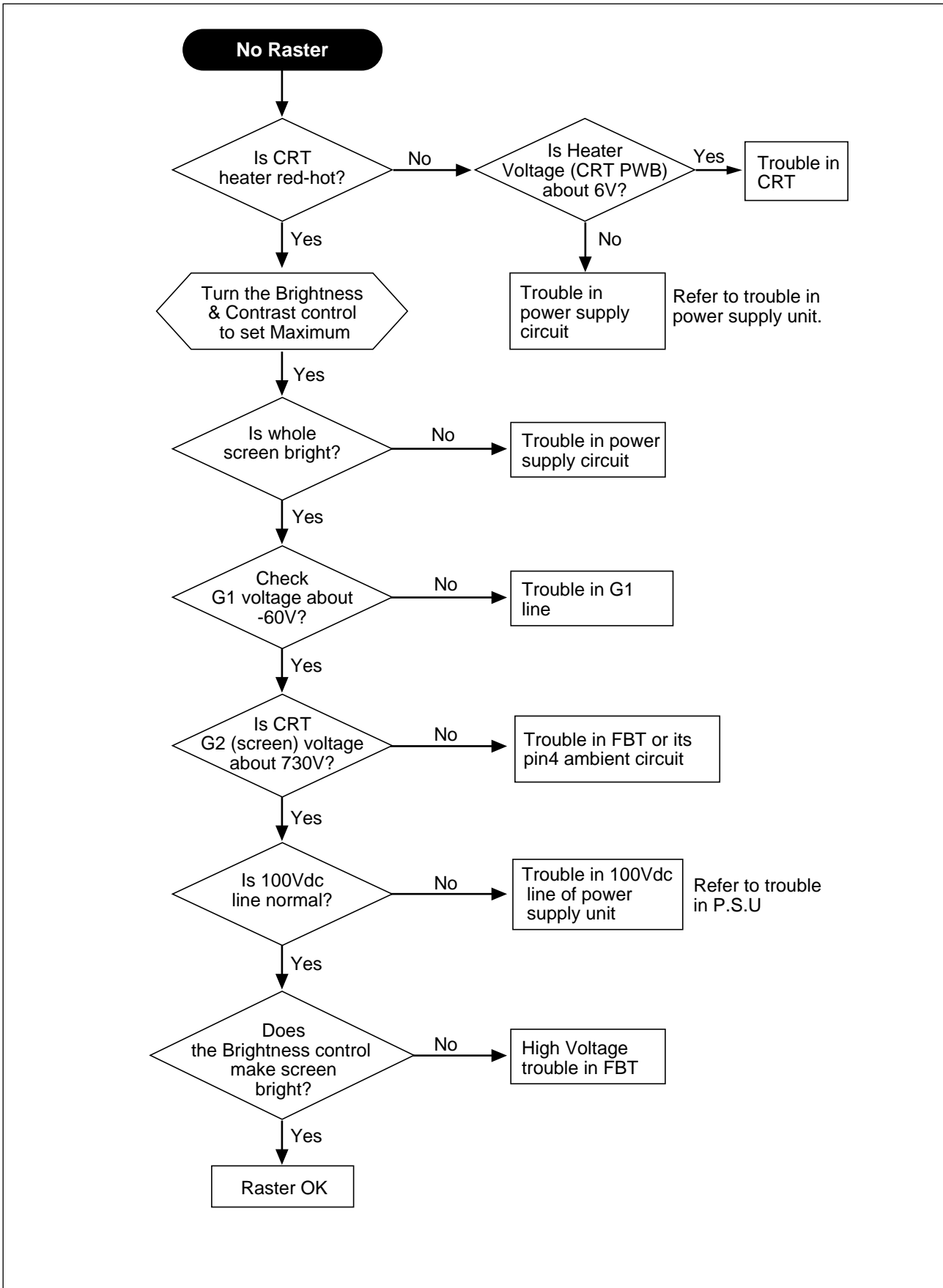

3. A Missing Color

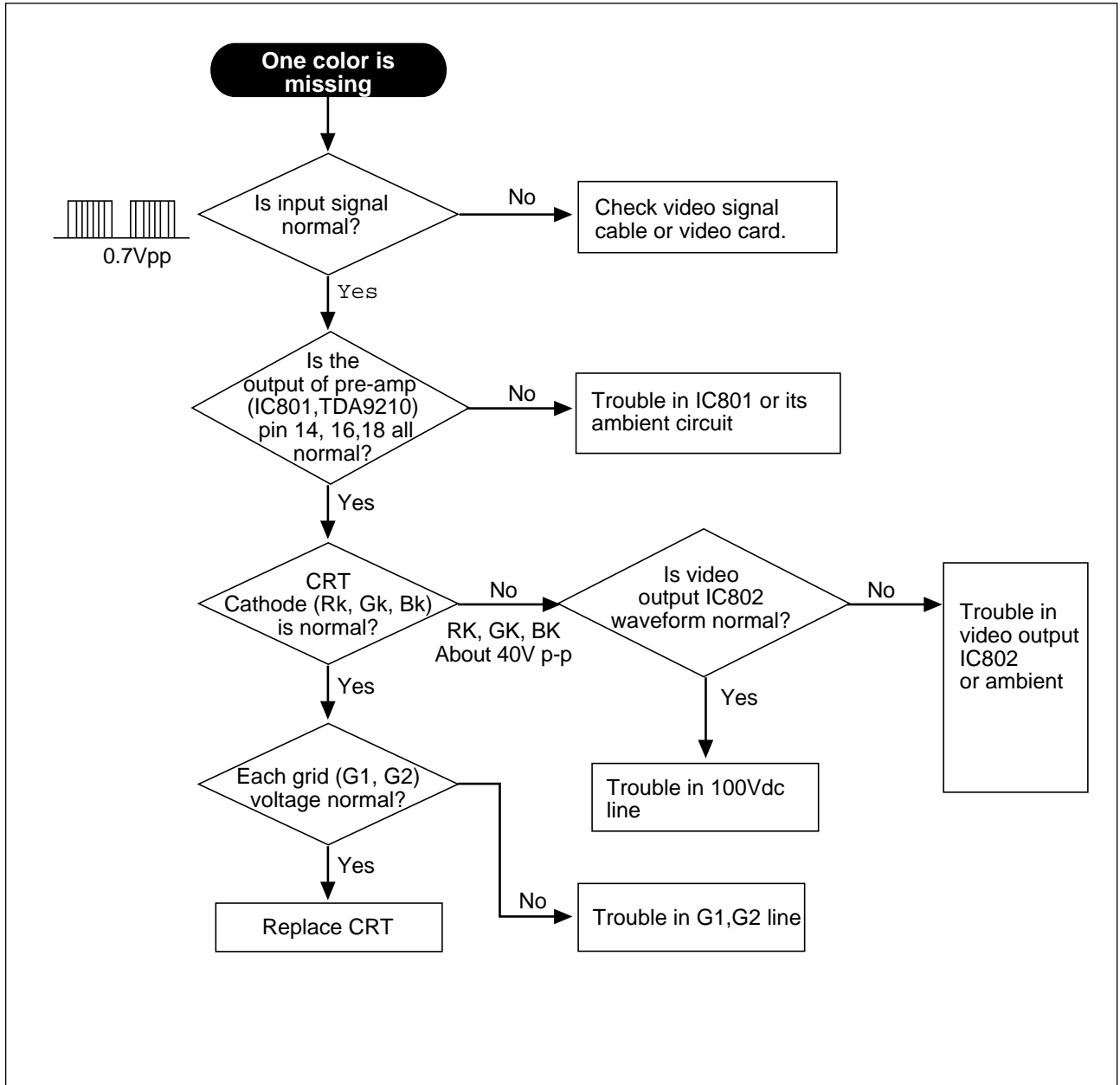

4. Abnormal OSD Font

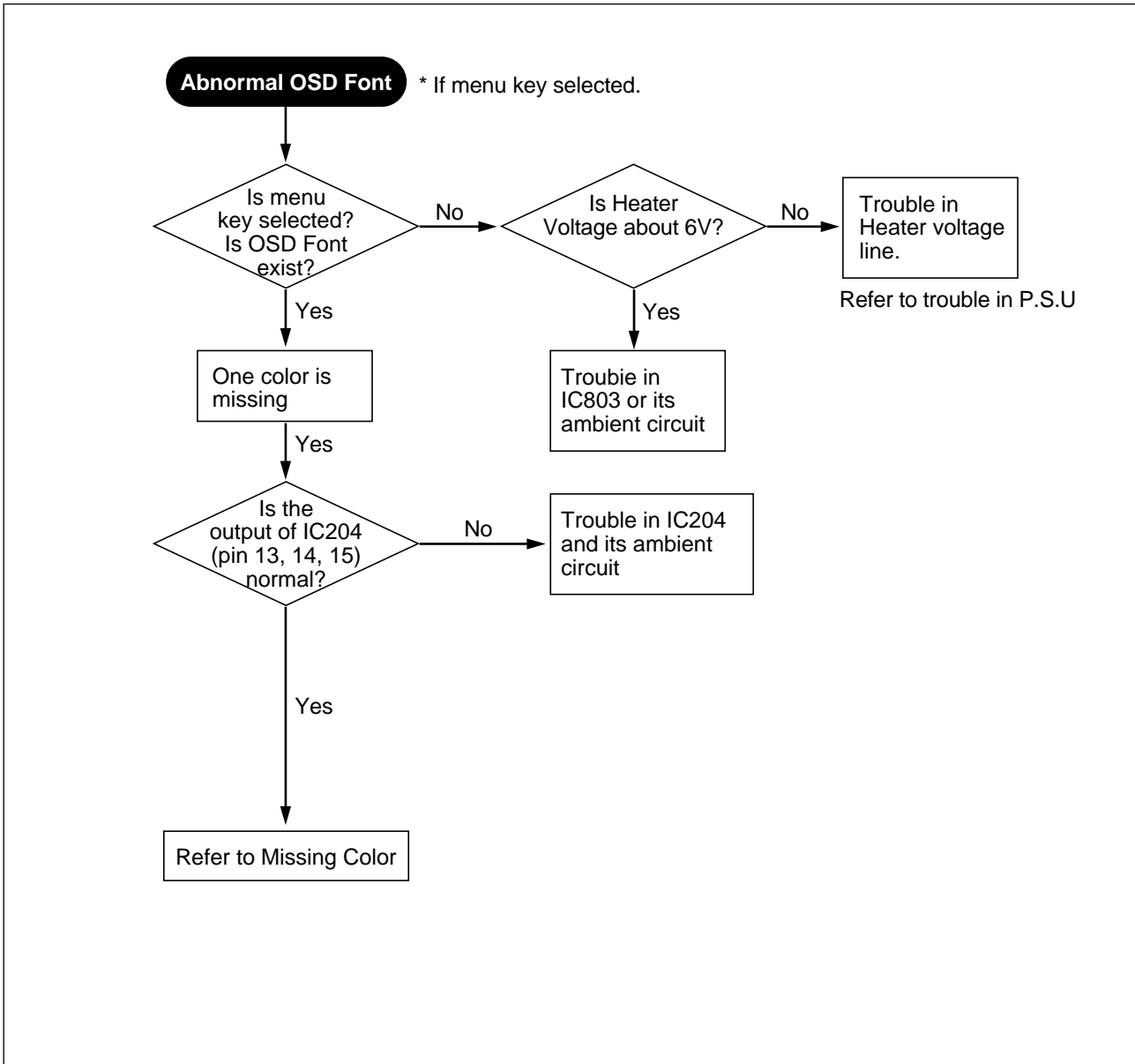

5. Horizontal Output Circuit

MODE	B+ Voltage
VGA	60Vdc
Super VGA	72Vdc
54KHz	110Vdc

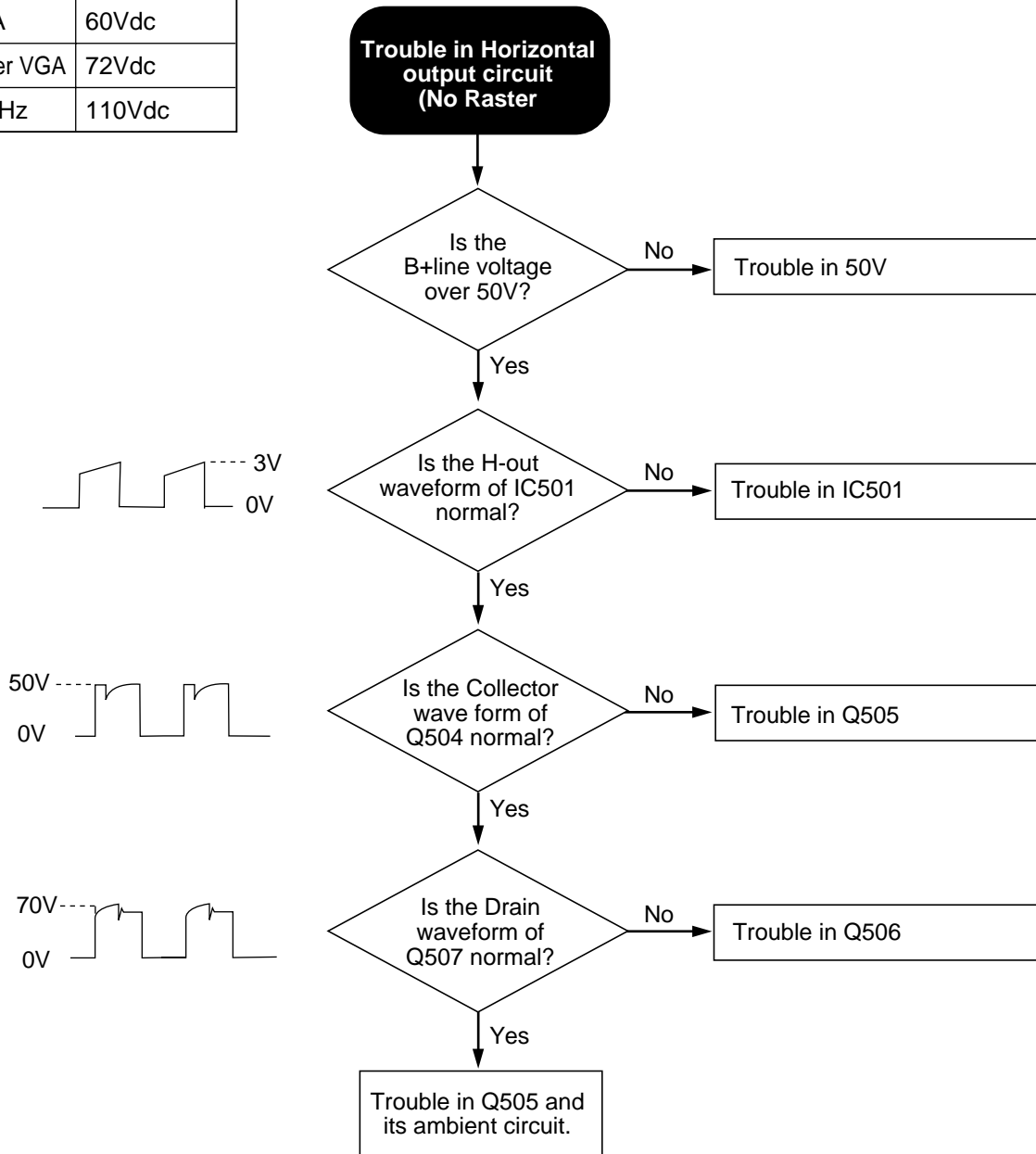

6. Unstable Picture

6-1. Horizontal

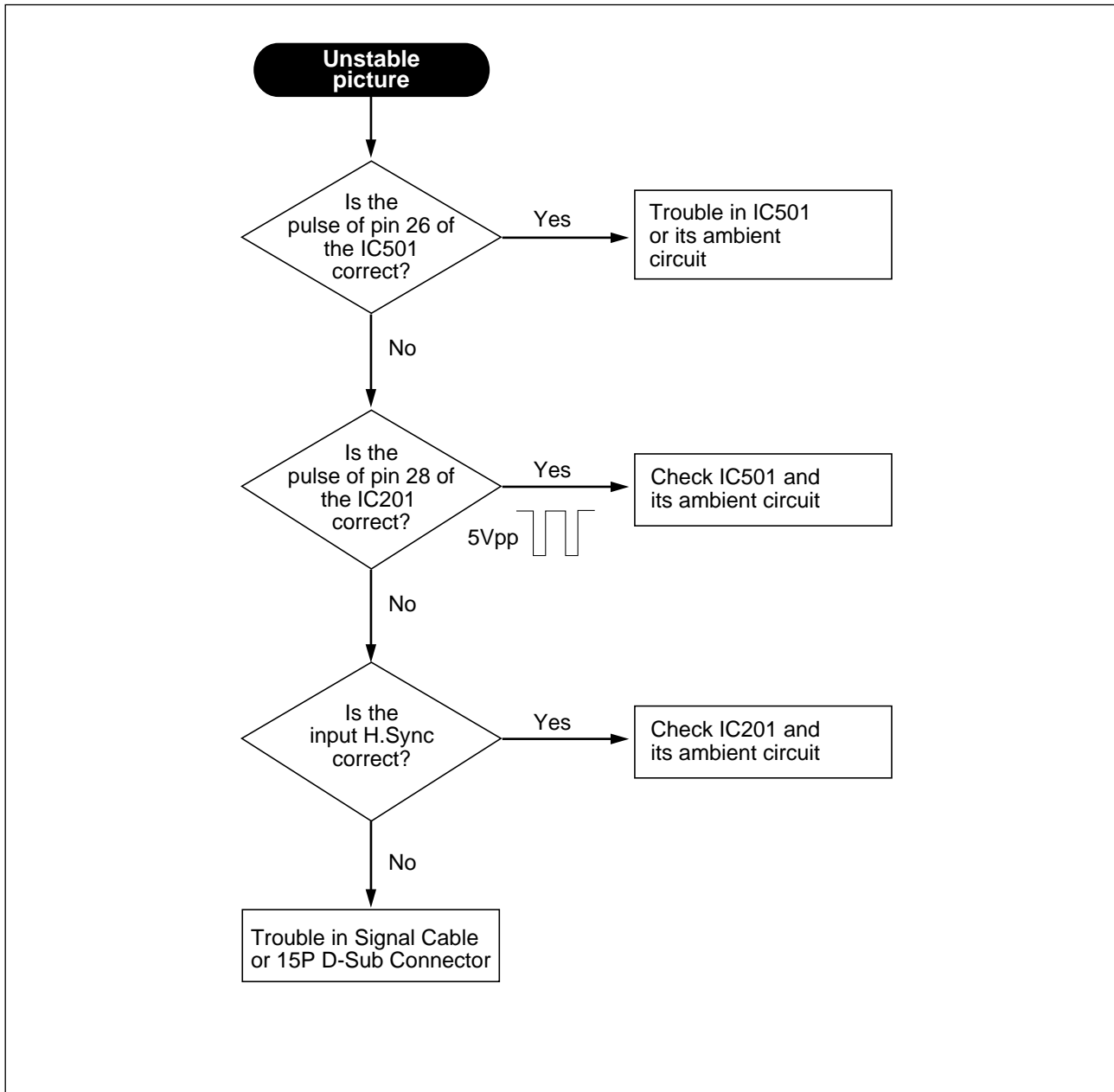

6-2. Vertical

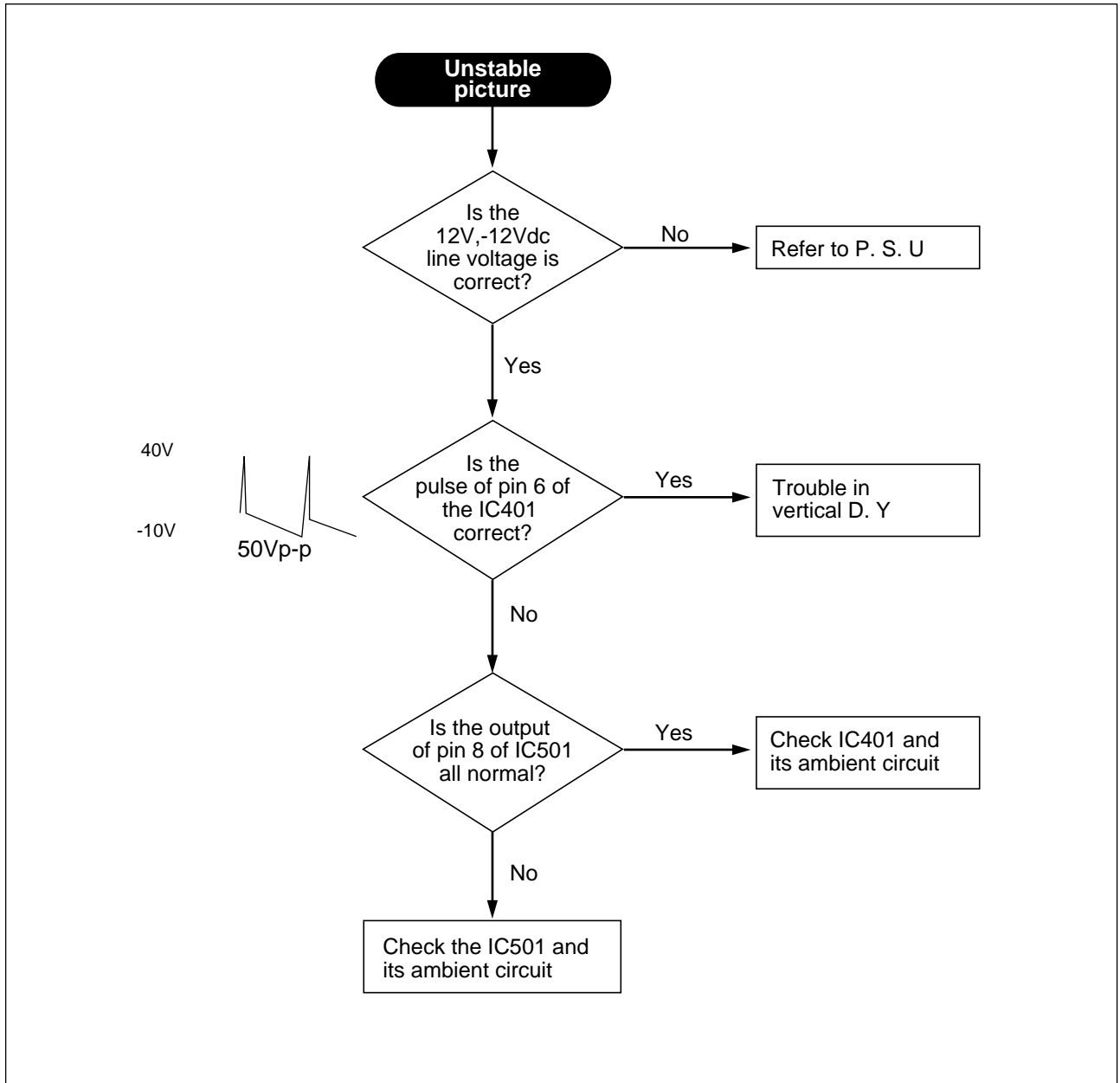

7. Focus

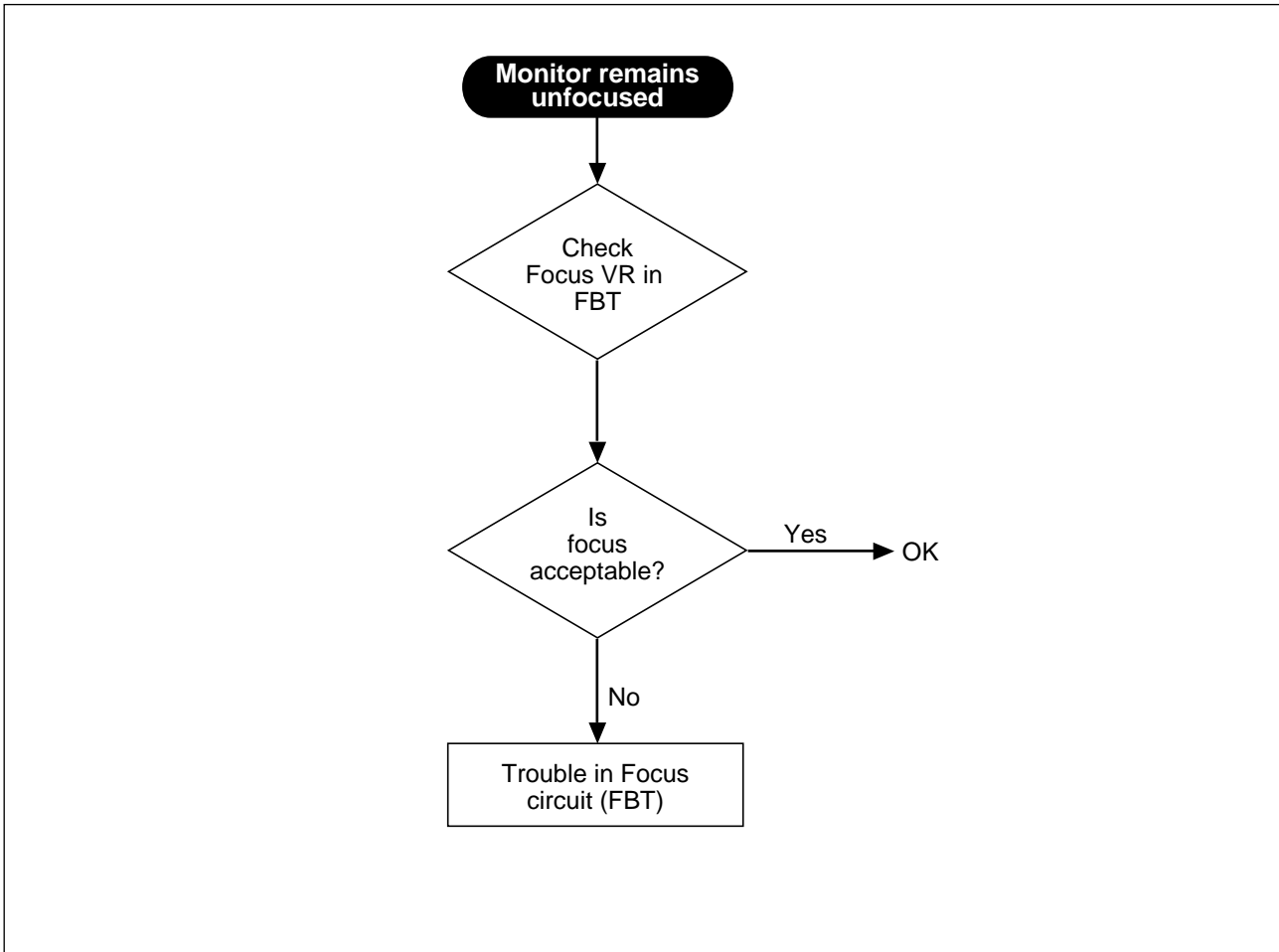

8. Convergence

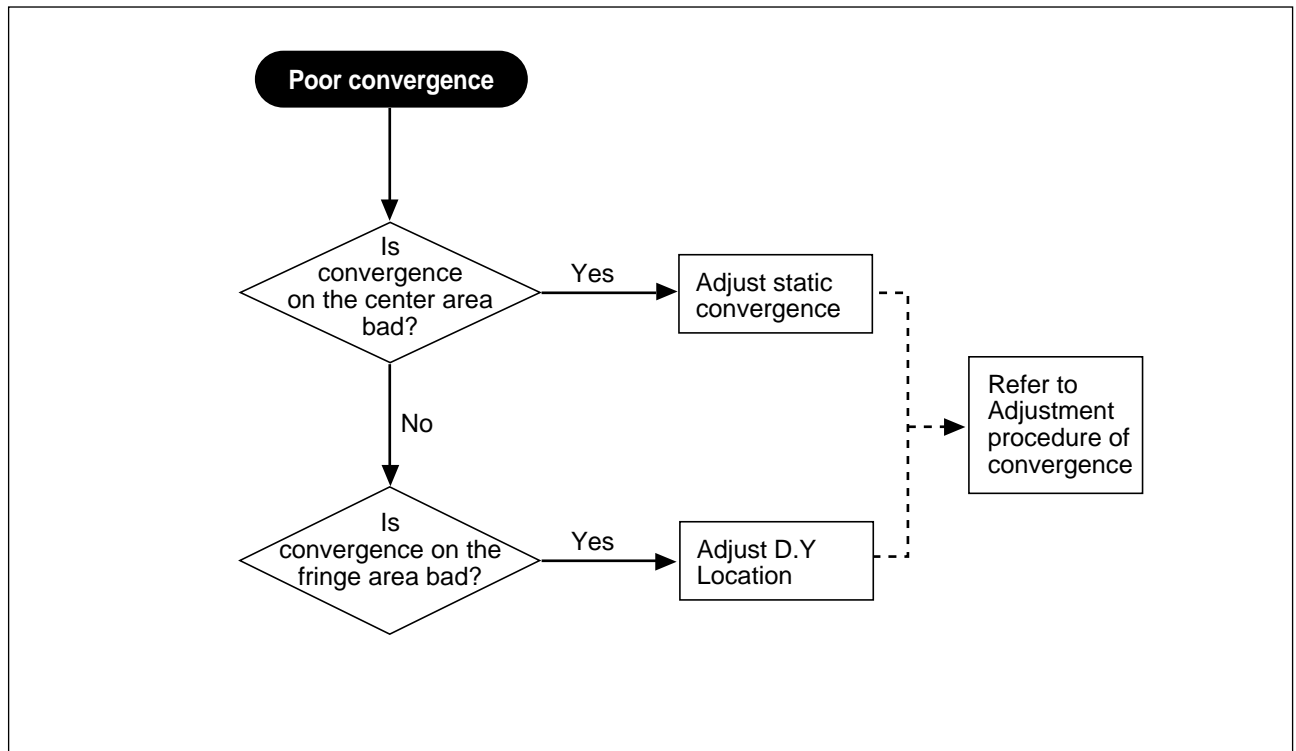

9. Abnormal Picture

* At first, adjust controls in the OSD Menu

9-1. Horizontal Size

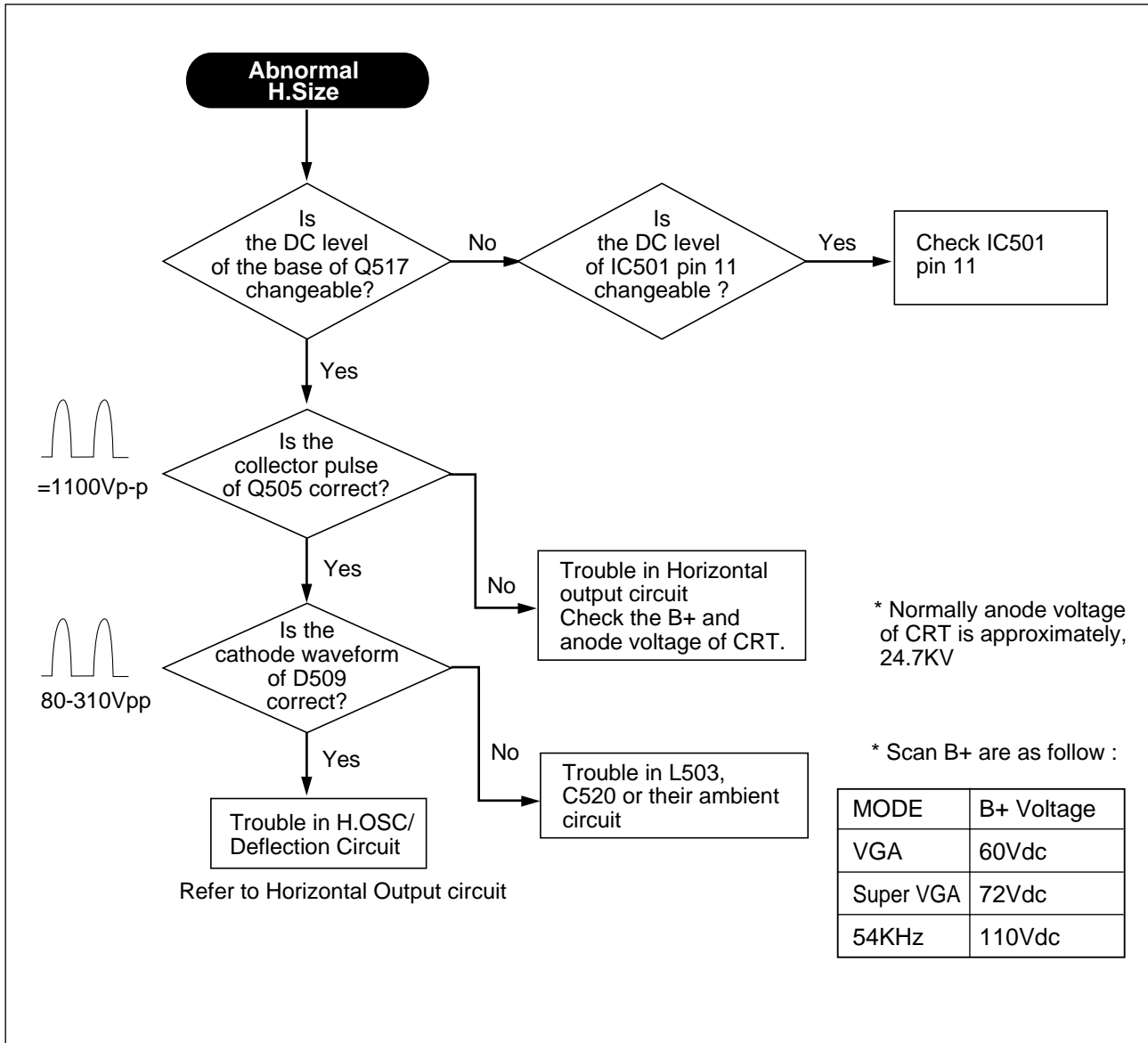

9-2. Vertical Size

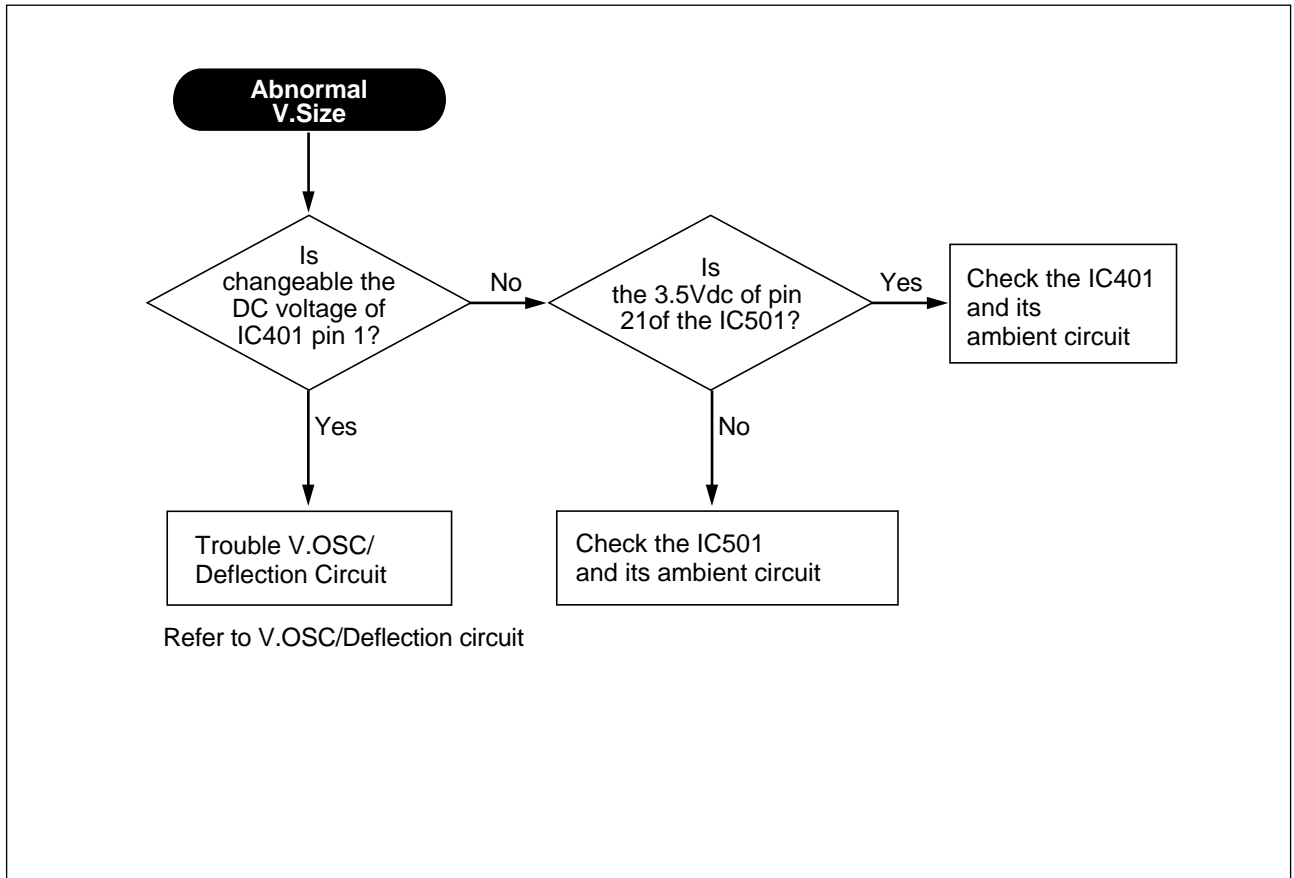

10. Side-Pincushion Circuit

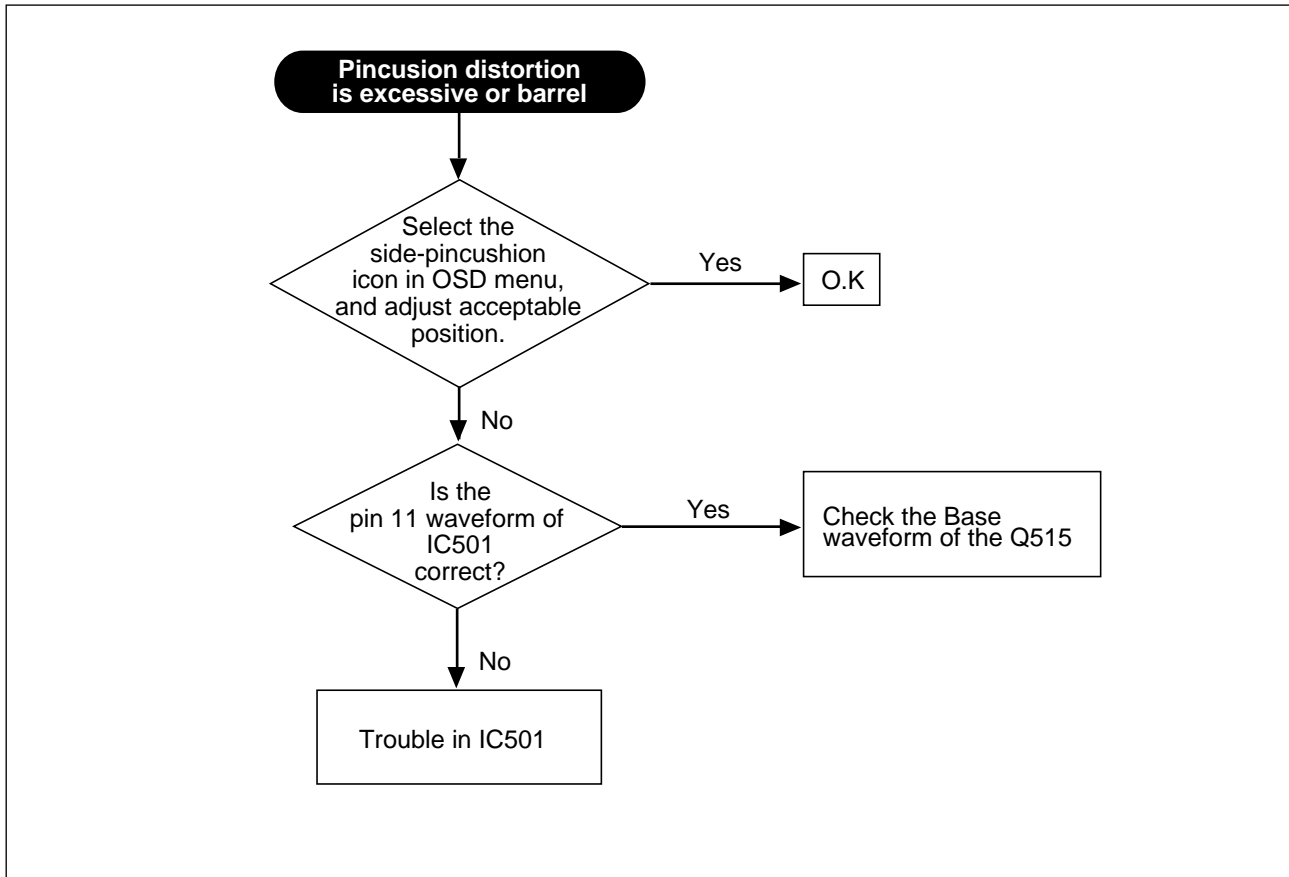

11. Power Supply Unit (P.S.U)

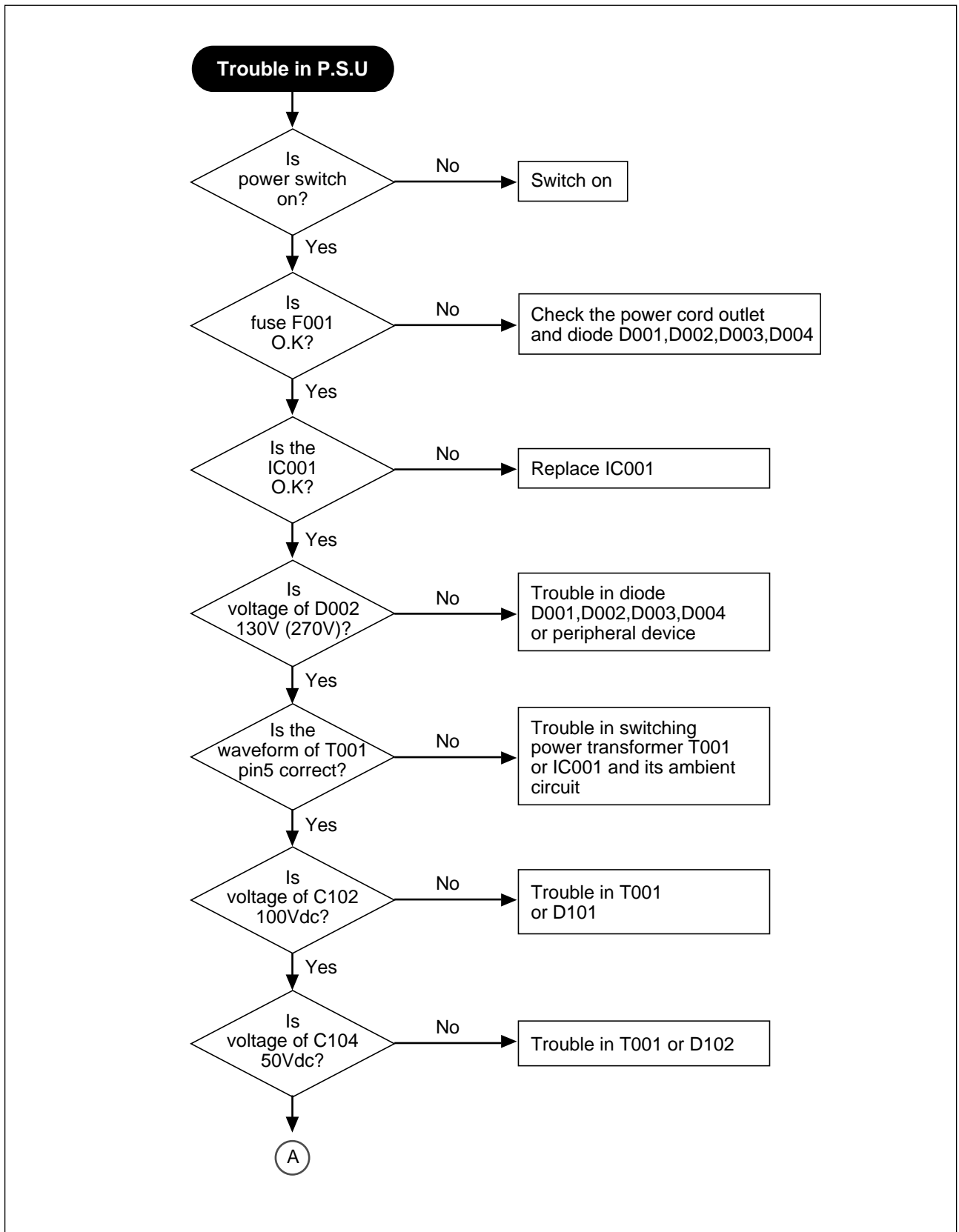

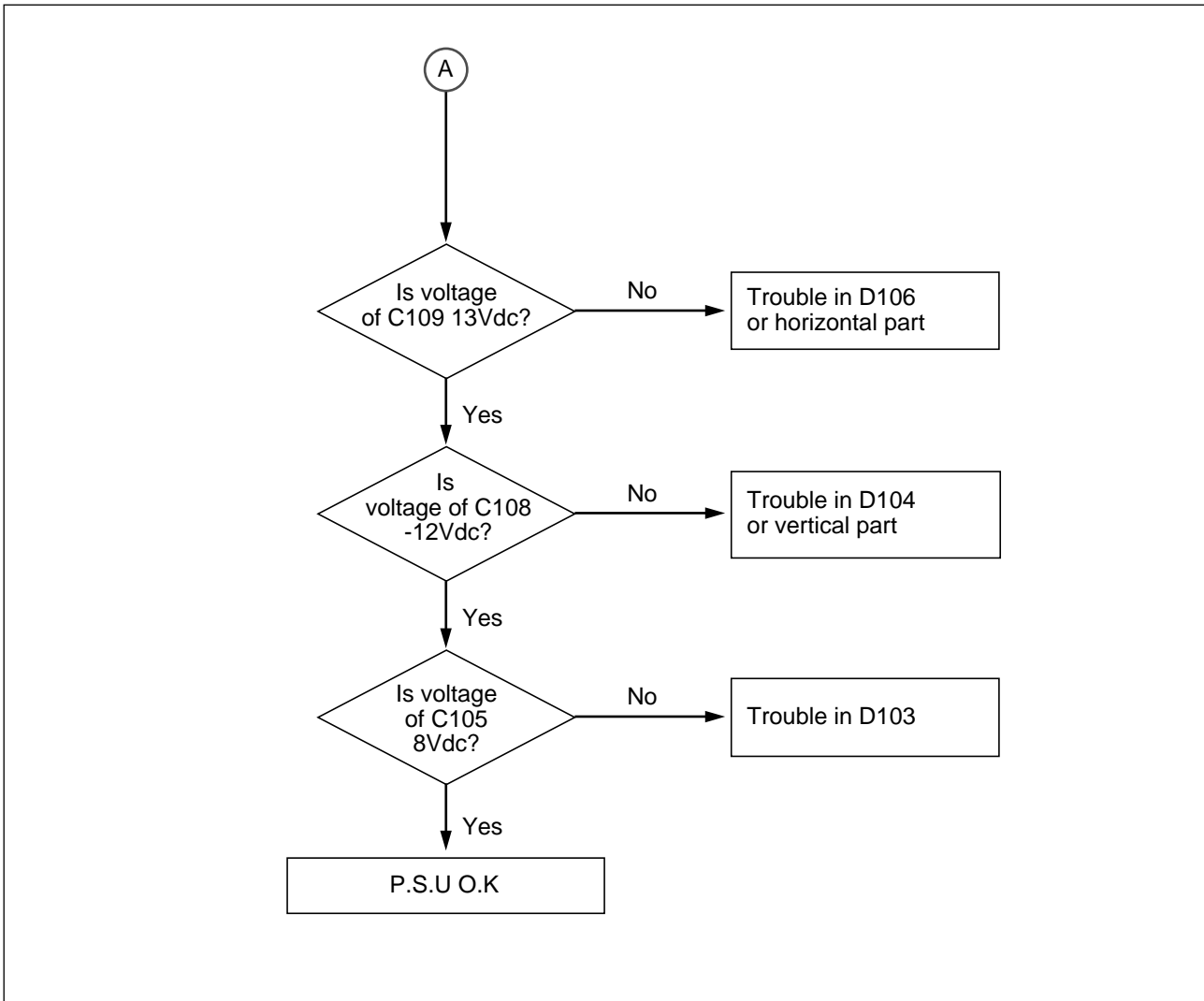

BLOCK DIAGRAM

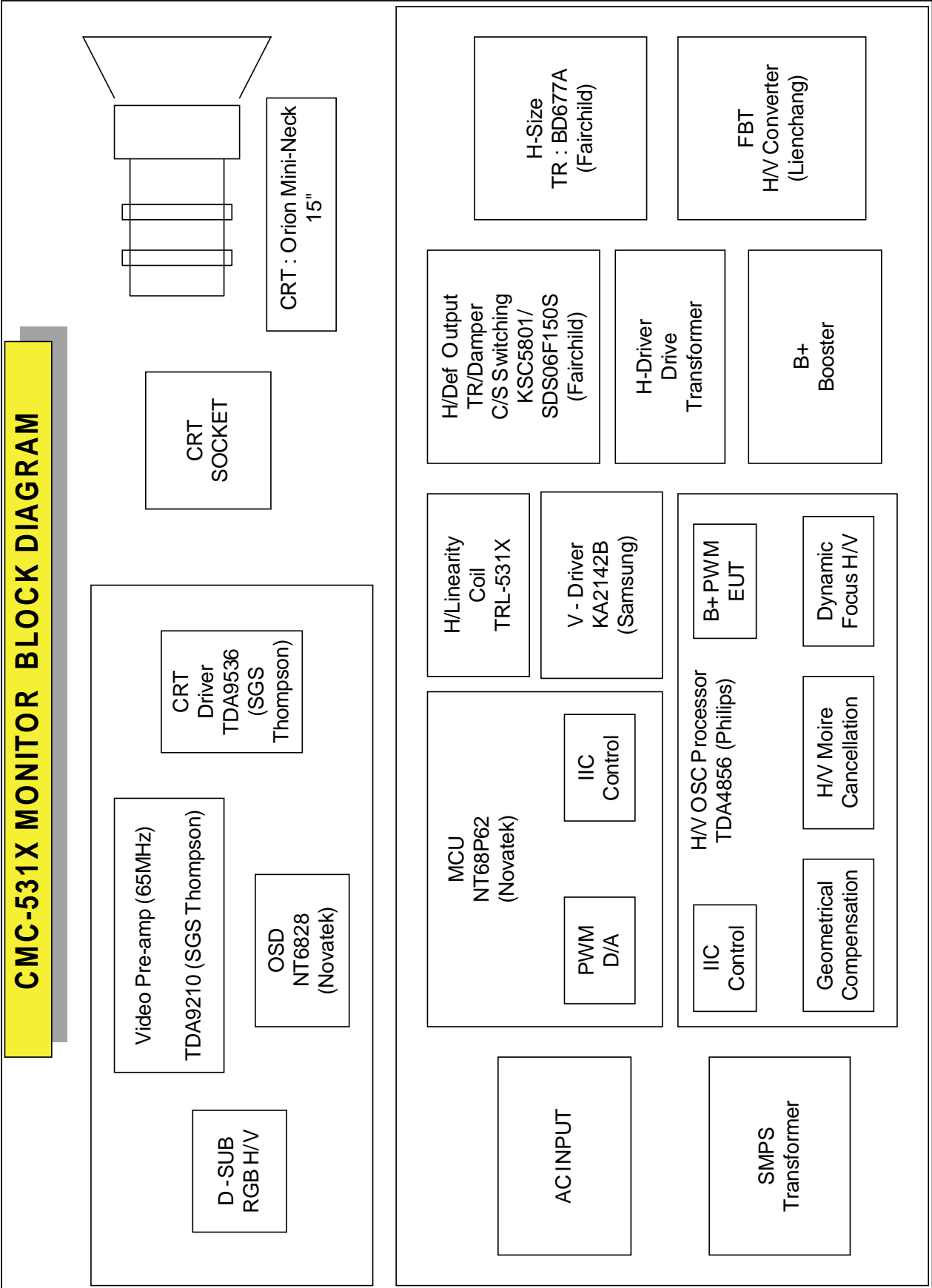

PCB LAYOUT

Main PCB Component Side

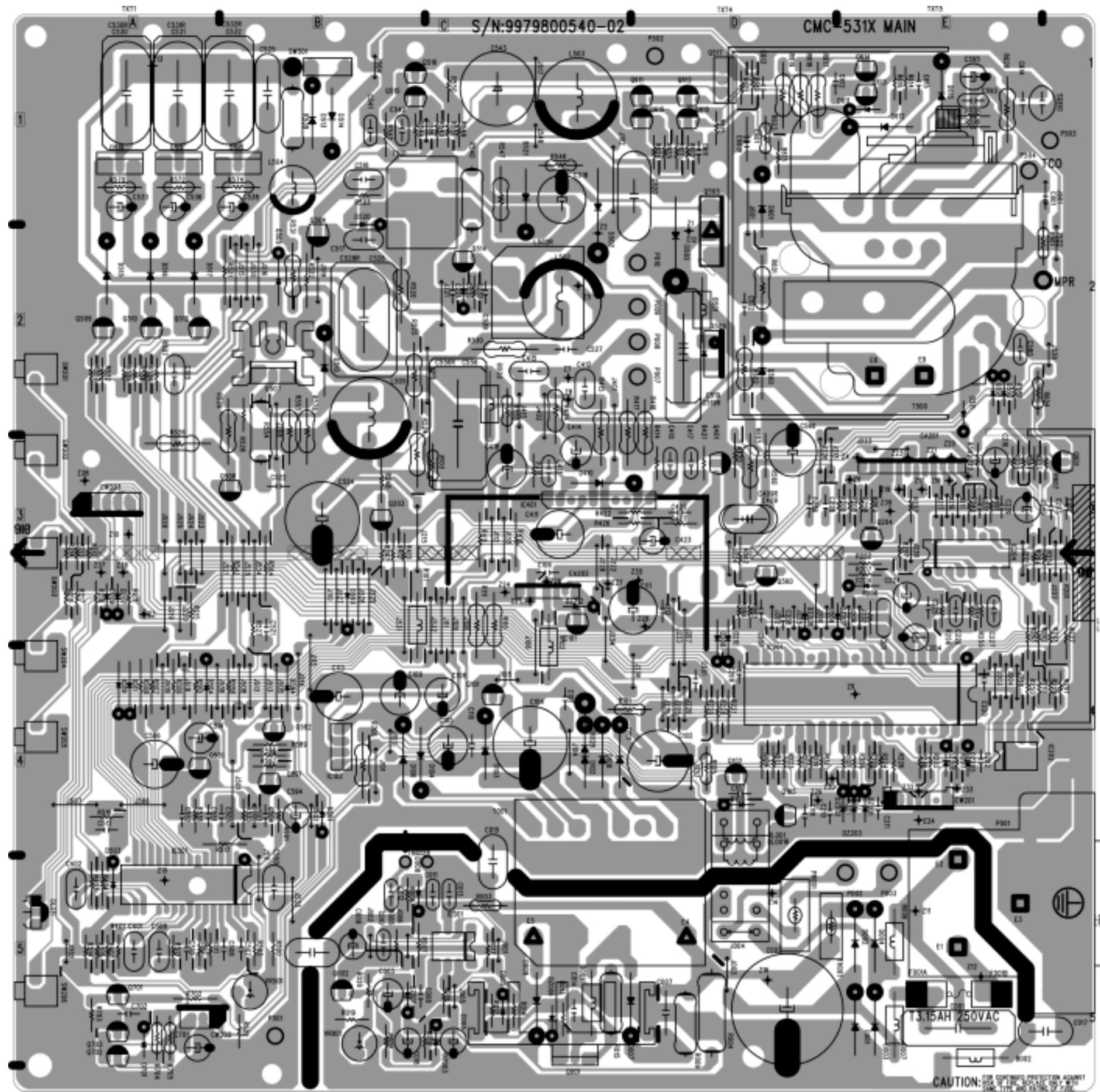

Main PCB Solder Side

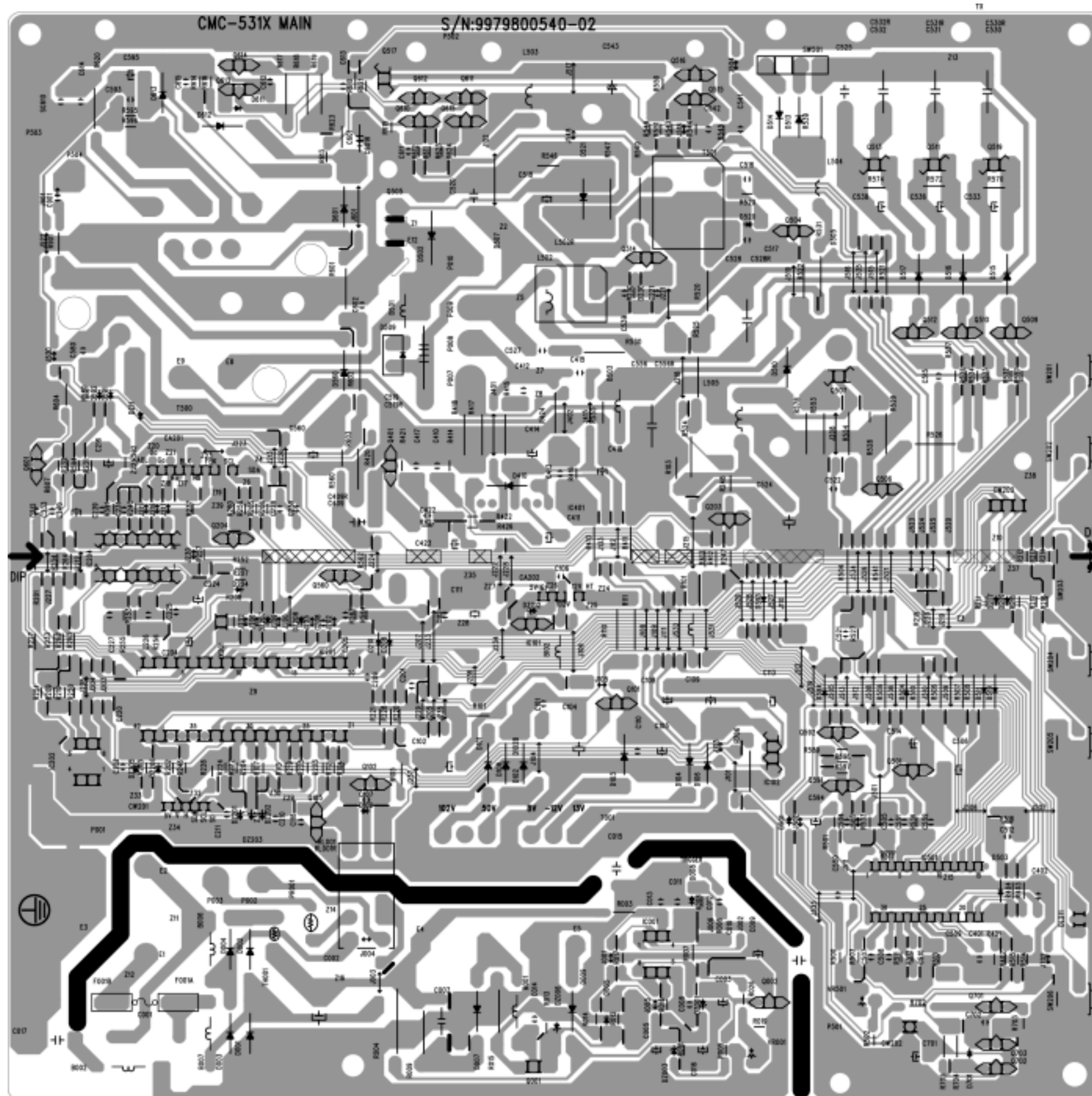

SCHEMATIC DIAGRAM

Power & Connection Section

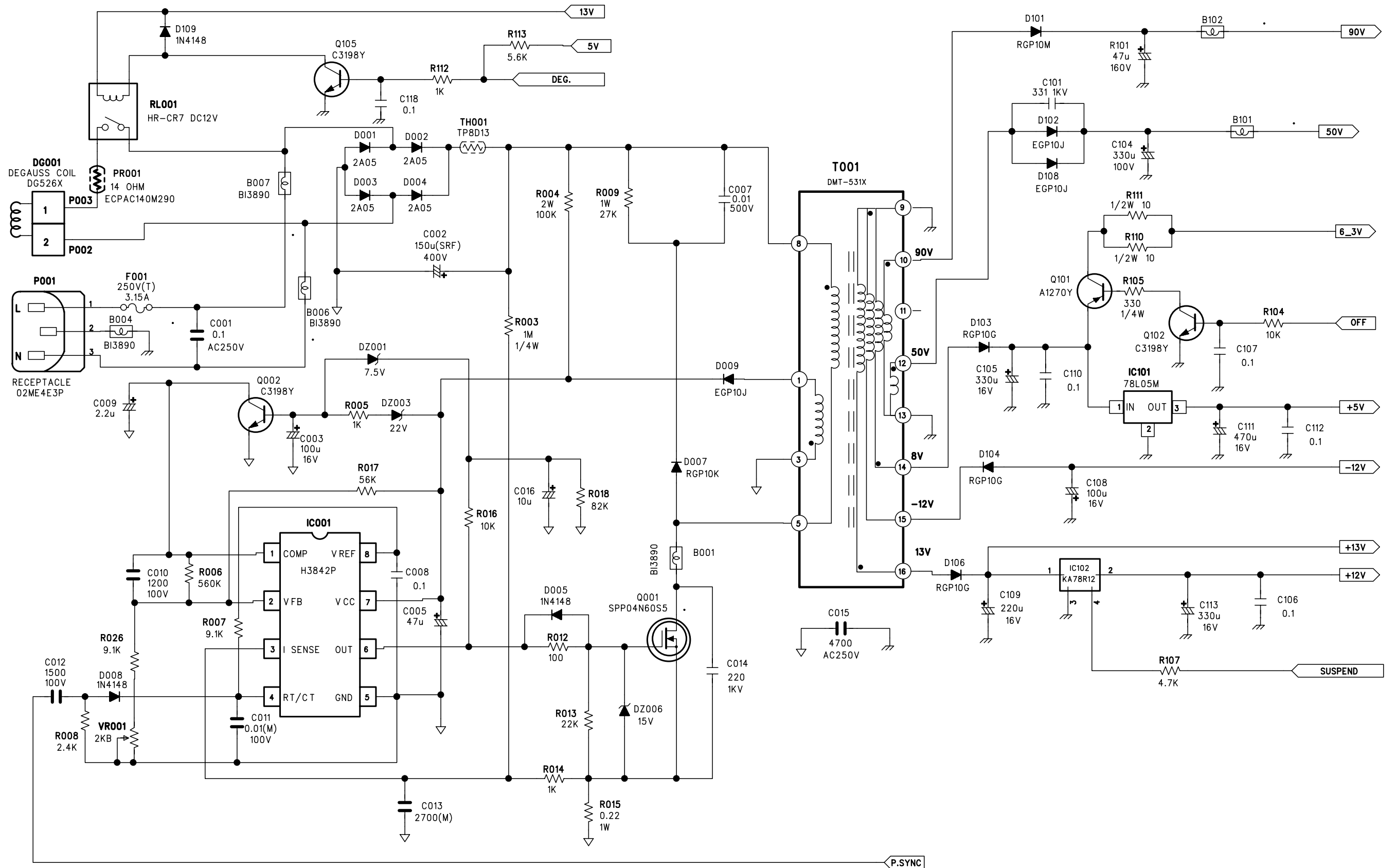

Control & Vert. out Section

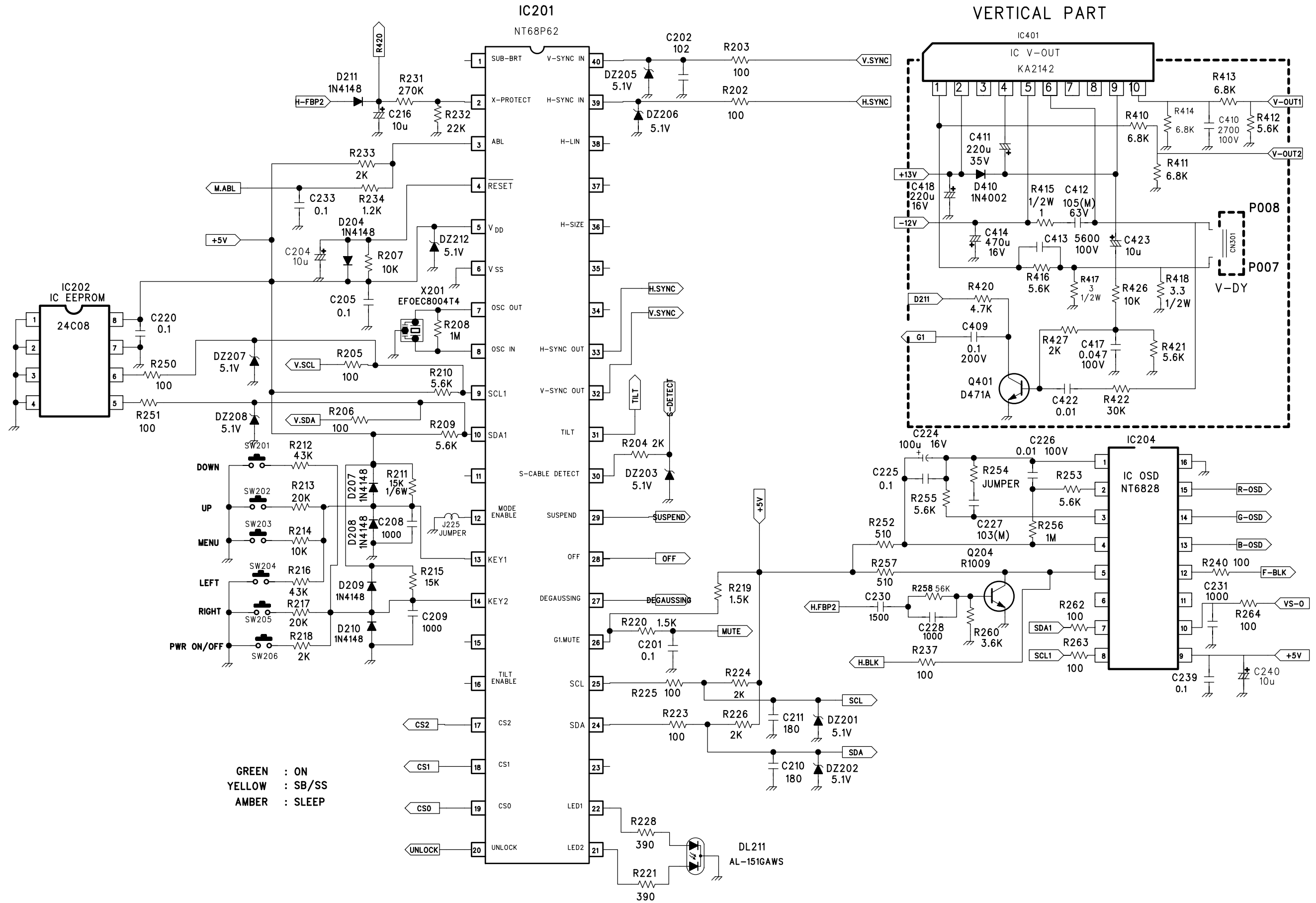

Video Section

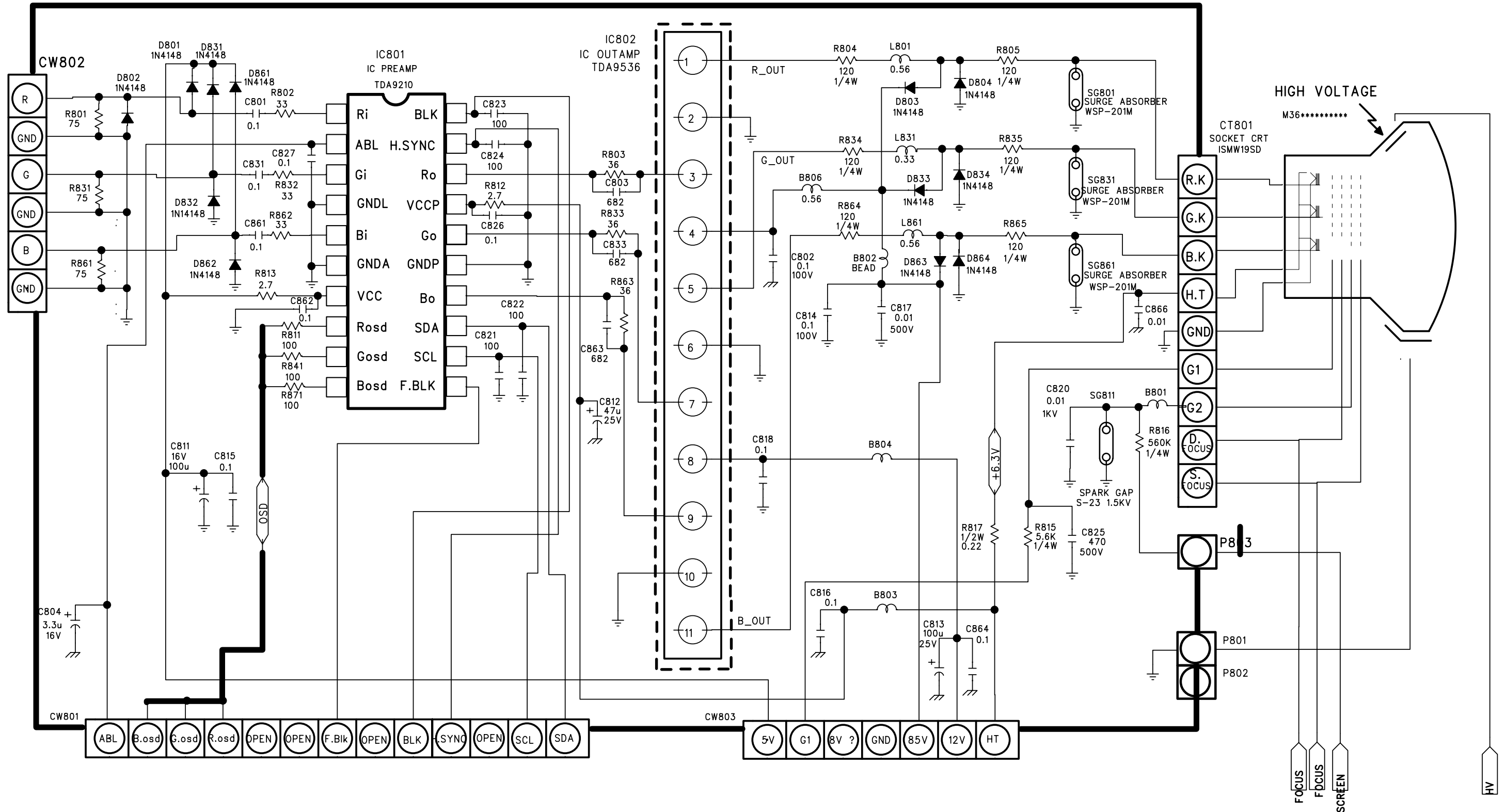

EXPLODED VIEW DIAGRAM

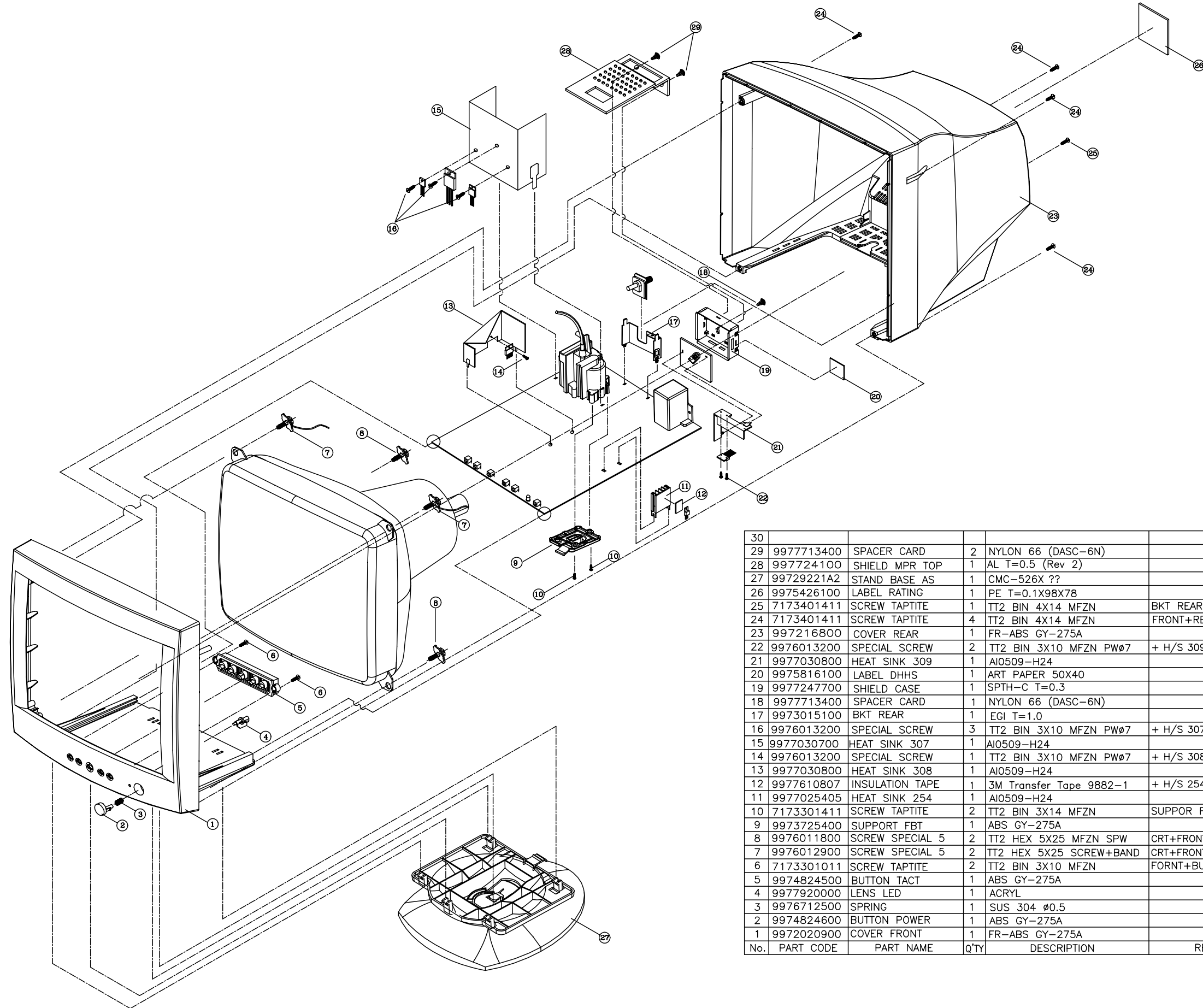

30					
29	9977713400	SPACER CARD	2	NYLON 66 (DASC-6N)	
28	997724100	SHIELD MPR TOP	1	AL T=0.5 (Rev 2)	
27	99729221A2	STAND BASE AS	1	CMC-526X ??	
26	9975426100	LABEL RATING	1	PE T=0.1X98X78	
25	7173401411	SCREW TAPTITE	1	TT2 BIN 4X14 MFZN	BKT REAR+REAR
24	7173401411	SCREW TAPTITE	4	TT2 BIN 4X14 MFZN	FRONT+REAR
23	997216800	COVER REAR	1	FR-ABS GY-275A	
22	9976013200	SPECIAL SCREW	2	TT2 BIN 3X10 MFZN PW#7	+ H/S 309
21	9977030800	HEAT SINK 309	1	AI0509-H24	
20	9975816100	LABEL DHHS	1	ART PAPER 50X40	
19	9977247700	SHIELD CASE	1	SPTH-C T=0.3	
18	9977713400	SPACER CARD	1	NYLON 66 (DASC-6N)	
17	9973015100	BKT REAR	1	EGI T=1.0	
16	9976013200	SPECIAL SCREW	3	TT2 BIN 3X10 MFZN PW#7	+ H/S 307
15	9977030700	HEAT SINK 307	1	AI0509-H24	
14	9976013200	SPECIAL SCREW	1	TT2 BIN 3X10 MFZN PW#7	+ H/S 308
13	9977030800	HEAT SINK 308	1	AI0509-H24	
12	9977610807	INSULATION TAPE	1	3M Transfer Tape 9882-1	+ H/S 254
11	9977025405	HEAT SINK 254	1	AI0509-H24	
10	7173301411	SCREW TAPTITE	2	TT2 BIN 3X14 MFZN	SUPPOR FBT+FBT
9	9973725400	SUPPORT FBT	1	ABS GY-275A	
8	9976011800	SCREW SPECIAL 5	2	TT2 HEX 5X25 MFZN SPW	CRT+FRONT
7	9976012900	SCREW SPECIAL 5	2	TT2 HEX 5X25 SCREW+BAND	CRT+FRONT D-COIL WIRE
6	7173301011	SCREW TAPTITE	2	TT2 BIN 3X10 MFZN	FORNT+BUTTON TACT
5	9974824500	BUTTON TACT	1	ABS GY-275A	
4	9977920000	LENS LED	1	ACRYL	
3	9976712500	SPRING	1	SUS 304 #0.5	
2	9974824600	BUTTON POWER	1	ABS GY-275A	
1	9972020900	COVER FRONT	1	FR-ABS GY-275A	
No.	PART CODE	PART NAME	Q'TY	DESCRIPTION	REMARK

INFORMATION OF PART DESCRIPTION

Important Safety Notice

Components identified with the International Symbol have special characteristics important for safety. When replacing any components, use only manufacturer's specified parts.

Abbreviation of Description

RESISTOR Description

Allowance	
F	± 1%
J	± 5%
K	± 10%
M	± 20%
G	± 2%

Example:

Fig & Index	Part No	Description
R101	Resistors	
	RD-4Z820J	Carbon: 82J
R102	RD-4Z201J	Carbon 1/4W-200J

CAPACITOR Description

Allowance	
C	± 0.25pF
D	± 0.5%
F	± 1pF
J	± 5%
K	± 10%
P	± 100% ~ 0%
Z	± 80% ~ -

Example:

Fig & Index	Part No	Description
C102	Capacitors	
	CCXF1H104Z	Ceramic 50V 0.1µF Z
	CCXB1H331K	Ceramic 50V 330PF K
C105	CMXM 2A224J	MYLAR 100V 0.22µFJ

ELECTRICAL PARTS LIST

The components identified by mark \triangle have special characteristics important for safety and x-ray radiation. These should be replaced only with the types specified in the parts list.

LOC	PART-CODE	PART-NAME	PART-DESC	LOC	PART-CODE	PART-NAME	PART-DESC
00001	9979800540	PCB MAIN	T=1.6*246*247 (531X)	C210	CCXB1H181K	C CERA	50V B 180PF K (TAPPING)
00002	9979800548	PCB CRT	T=1.6*108*82(531X)	C211	CCXB1H181K	C CERA	50V B 180PF K (TAPPING)
00020	W3475N731-	CORD POWER	3 H05VV-F 3X0.75 1.8 IV	C216	CEXF1H100V	C ELECTRO	50V RSS 10MF (5X11) TP
B001	5PB13890--	COIL BEAD	BI3890	C220	CCXF1H104Z	C CERA	50V F 0.1MF Z
B006	5PB13890--	COIL BEAD	BI3890	C224	CEXF1C101V	C ELECTRO	16V RSS 100MF (6.3X11) TP
B007	5PB13890--	COIL BEAD	BI3890	C225	CCXF1H104Z	C CERA	50V F 0.1MF Z
B101	5PB13857--	COIL BEAD	BI3857(AXIAL)	C226	CMXM2A103J	C MYLAR	100V 0.01MF J (TP)
B102	5PB13857--	COIL BEAD	BI3857(AXIAL)	C227	CMXM2A103J	C MYLAR	100V 0.01MF J (TP)
B501	5PB13857--	COIL BEAD	BI3857(AXIAL)	C228	CCXB1H102K	C CERA	50V B 1000PF K (TAPPING)
B503	5PB13857--	COIL BEAD	BI3857(AXIAL)	C230	CCXB1H152K	C CERA	50V B 1500PF K (TAPPING)
B801	5PB13857--	COIL BEAD	BI3857(AXIAL)	C231	CCXB1H102K	C CERA	50V B 1000PF K (TAPPING)
B802	5PB13857--	COIL BEAD	BI3857(AXIAL)	C233	CCXF1H104Z	C CERA	50V F 0.1MF Z
B803	5PB13857--	COIL BEAD	BI3857(AXIAL)	C239	CCXF1H104Z	C CERA	50V F 0.1MF Z
B804	5PB13857--	COIL BEAD	BI3857(AXIAL)	C240	CEXF1H100V	C ELECTRO	50V RSS 10MF (5X11) TP
\triangle C001	CL1UC3104M	C LINE ACROSS	WORLD AC250V 0.1UF M R.47	C401	CMXM2A104J	C MYLAR	100V 0.1MF J (TP)
\triangle C002	CEYP2G151Z	C ELECTRO	400V SMH 150MF (25.4*40)	C402	CMXM2A154J	C MYLAR	100V 0.15MF J (TP)
C003	CEXF1C101V	C ELECTRO	16V RSS 100MF (6.3X11) TP	C409	CMXM2E104J	C MYLAR	250V 0.1MF J
C005	CEXF1H470V	C ELECTRO	50V RSS 47MF (6.3X11) TP	C410	CMXM2A272J	C MYLAR	100V 2700PF J (TP)
C007	CCXB2H103K	C CERA	HIKB 500V 0.01MF K	C411	CEXF1V221V	C ELECTRO	35V RSS 220MF (10X12.5)TP
C008	CCXF1H104Z	C CERA	50V F 0.1MF Z	C412	CMXL1J105J	C MYLAR	MEU 63V 1MF J
C009	CEXF1H229V	C ELECTRO	50V RSS 2.2MF (5X11) TP	C413	CMXM2A562J	C MYLAR	100V 5600PF J (TP)
C010	CMXM2A102J	C MYLAR	100V 1000PF J (TP)	C414	CEXF1C471V	C ELECTRO	16V RSS 470MF (10X12.5)TP
C011	CMXM2A103J	C MYLAR	100V 0.01MF J (TP)	C417	CMXM2A473J	C MYLAR	100V 0.047MF J (TP)
C012	CMXM2A152J	C MYLAR	100V 1500PF J (TP)	C418	CEXF1C221V	C ELECTRO	16V RSS 220MF (8X11.5) TP
C013	CMXM2A272J	C MYLAR	100V 2700PF J (TP)	C422	CCXB1H103K	C CERA	50V B 0.01MF K
C014	CCXB3A221K	C CERA	1KV B 220PF K (TAPPING)	C423	CEXF1H100V	C ELECTRO	50V RSS 10MF (5X11) TP
\triangle C015	CH1FDF472M	C CERA AC	2.5KV 4700PF M AC250V	C504	CMXM2A223J	C MYLAR	100V 0.022MF J TP
C016	CEXF1H100V	C ELECTRO	50V RSS 10MF (5X11) TP	C505	CMXM2A332J	C MYLAR	100V 3300PF J (TP)
C101	CCXB3A331K	C CERA	1KV B 330PF K (TAPPING)	C506	CEXF1C331V	C ELECTRO	16V RSS 330MF (8X11.5) TP
C102	CEXF2C470V	C ELECTRO	160V RSS 47MF (13X25) TP	C507	CMXM2A562J	C MYLAR	100V 5600PF J (TP)
C104	CEXF2A331V	C ELECTRO	100V RSS 330MF (16X25) TP	C508	CMXM2A103J	C MYLAR	100V 0.01MF J (TP)
C105	CEXF1C331V	C ELECTRO	16V RSS 330MF (8X11.5) TP	C509	CMXM2A104J	C MYLAR	100V 0.1MF J (TP)
C106	CCXF1H104Z	C CERA	50V F 0.1MF Z	C510	CMXM2A822J	C MYLAR	100V 8200PF J (TP)
C107	CCXF1H104Z	C CERA	50V F 0.1MF Z	C512	CCXF1H104Z	C CERA	50V F 0.1MF Z
C108	CEXF1C101V	C ELECTRO	16V RSS 100MF (6.3X11) TP	C514	CEXF1C220V	C ELECTRO	RSS 16V 22MF 5*11
C109	CEXF1C221V	C ELECTRO	16V RSS 220MF (8X11.5) TP	C515	CMXM2A104J	C MYLAR	100V 0.1MF J (TP)
C110	CCXF1H104Z	C CERA	50V F 0.1MF Z	C516	CMXM2A104J	C MYLAR	100V 0.1MF J (TP)
C111	CEXF1C471V	C ELECTRO	16V RSS 470MF (10X12.5)TP	C517	CMXM2A104J	C MYLAR	100V 0.1MF J (TP)
C112	CCXF1H104Z	C CERA	50V F 0.1MF Z	C519	CMYH3C472J	C MYLAR	1.6KV BUP 4700PF J
C113	CEXF1C331V	C ELECTRO	16V RSS 330MF (8X11.5) TP	C520	CMXE2J562J	C MYLAR	630V PU 5600PF J (TP)
C118	CCXF1H104Z	C CERA	50V F 0.1MF Z	C521	CCXB1H271K	C CERA	50V B 270PF K (TAPPING)
C201	CCXF1H104Z	C CERA	50V F 0.1MF Z	C522	CCXB2H331K	C CERA	500V B 330PF K (TAPPING)
C202	CCXB1H102K	C CERA	50V B 1000PF K (TAPPING)	C524	CEXF2A331V	C ELECTRO	100V RSS 330MF (16X25) TP
C204	CEXF1H100V	C ELECTRO	50V RSS 10MF (5X11) TP	C527	CCXB3A102K	C CERA	1KV B 1000PF K (TAPPING)
C205	CCXF1H104Z	C CERA	50V F 0.1MF Z	C528	CMYF2D564J	C MYLAR	200V MPP 0.56MF J
C208	CCXB1H102K	C CERA	50V B 1000PF K (TAPPING)	C531	CMXF2D224J	C MYLAR	MPP 200V 0.22MF J
C209	CCXB1H102K	C CERA	50V B 1000PF K (TAPPING)	C532	CMYF2D684J	C MYLAR	200V MPP 0.68MF J

LOC	PART-CODE	PART-NAME	PART-DESC		LOC	PART-CODE	PART-NAME	PART-DESC
C536	CEXF1H109V	C ELECTRO	50V RSS 1MF (5X11) TP		CA202	9970770028	CONN AS	SMH200-07+YBNH200-07=270
C538	CEXF1H109V	C ELECTRO	50V RSS 1MF (5X11) TP		CG001	9970710245	CRT GND AS	0.12*6*16+BL101NG=580
C541	CMXM2A103J	C MYLAR	100V 0.01MF J (TP)	⚠	CT001	9979615027	CDT	M36QCZ100XX61
C542	CMXM2A152J	C MYLAR	100V 1500PF J (TP)		CT801	9979300012	SOCKET CRT	ISMW19SD
C543	CEXD1H339W	C ELECTRO	50V RHD 3.3MF(16*25)		CW201	9979220102	CONN WAFER	SMW200-07 (ST)
C550	CMXM2A224J	C MYLAR	100V 0.22MF J		CW801	9979220092	CONN WAFER	SMAW200-11 (ANGLE)
C551	CMXM2A222J	C MYLAR	100V 2200PF J (TP)		CW802	9979220087	CONN WAFER	SMAW200-06 (ANGLE)
C552	CMXM2A223J	C MYLAR	100V 0.022MF J TP		CW803	9979220088	CONN WAFER	SMAW200-07 (ANGLE)
C556	CMYF2D105J	C MYLAR	MPP 200V 1MF J	⚠	D001	D2A05-----	DIODE	2A05
C560	CEXF2C100V	C ELECTRO	160V RSS 10MF (10X16) TP	⚠	D002	D2A05-----	DIODE	2A05
C580	CMXM2A393J	C MYLAR	100V 0.039MF J (TP)	⚠	D003	D2A05-----	DIODE	2A05
C593	CMXM2A103J	C MYLAR	100V 0.01MF J (TP)	⚠	D004	D2A05-----	DIODE	2A05
C594	CEXF1H339V	C ELECTRO	50V RSS 3.3MF (5X11) TP		D005	DZN4148---	DIODE	1N4148 AUTO 52MM
C595	CEXF1H100V	C ELECTRO	50V RSS 10MF (5X11) TP		D007	DRGP10K---	DIODE	RGP10K
C601	CCXB3A103K	C CERA	HIKB 1KV 0.01MF K		D008	DZN4148---	DIODE	1N4148 AUTO 52MM
C611	CCXF1H104Z	C CERA	50V F 0.1MF Z		D009	DEGP10J---	DIODE	EGP10J
C612	CCXB2H101K	C CERA	500V B 100PF K (TAPPING)		D101	DRGP10M---	DIODE	RGP10M
C613	CCXB3A102K	C CERA	1KV B 1000PF K (TAPPING)		D102	DEGP10J---	DIODE	EGP10J
C614	CXSL3A470K	C CERA	1KV SL 47PF K (TP)		D103	DRGP10G---	DIODE	RGP10G
C615	CCXB2H271K	C CERA	500V B 270PF K (TAPPING)		D104	DRGP10G---	DIODE	RGP10G
C801	CCXF1H104Z	C CERA	50V F 0.1MF Z		D106	DRGP10G---	DIODE	RGP10G
C802	CMXL2E104J	C MYLAR	MEU 250V 0.1MF J		D108	DEGP10J---	DIODE	EGP10J
C803	CCXB1H682K	C CERA	50V B 6800PF K (TAPPING)		D109	DZN4148---	DIODE	1N4148 AUTO 52MM
C804	CEXF1H339V	C ELECTRO	50V RSS 3.3MF (5X11) TP		D204	DZN4148---	DIODE	1N4148 AUTO 52MM
C811	CEXF1C101V	C ELECTRO	16V RSS 100MF (6.3X11) TP		D207	DZN4148---	DIODE	1N4148 AUTO 52MM
C812	CEXF1E470V	C ELECTRO	25V RSS 47MF (5X11) TP		D208	DZN4148---	DIODE	1N4148 AUTO 52MM
C813	CEXF1E101V	C ELECTRO	25V RSS 100MF (6.3X11) TP		D209	DZN4148---	DIODE	1N4148 AUTO 52MM
C814	CMXL2E104J	C MYLAR	MEU 250V 0.1MF J		D210	DZN4148---	DIODE	1N4148 AUTO 52MM
C815	CCXF1H104Z	C CERA	50V F 0.1MF Z		D211	DZN4148---	DIODE	1N4148 AUTO 52MM
C816	CCXF1H104Z	C CERA	50V F 0.1MF Z		D410	D1N4002A--	DIODE	1N4002
C817	CCXB2H103K	C CERA	HIKB 500V 0.01MF K		D501	DZN4148---	DIODE	1N4148 AUTO 52MM
C818	CCXF1H104Z	C CERA	50V F 0.1MF Z		D502	DERD07-15-	DIODE	ERD07-15
C820	CCYB3A103K	C CERA	1KV B 0.01MF K		D503	DZN4148---	DIODE	1N4148 AUTO 52MM
C821	CCXB1H101K	C CERA	50V B 100PF K (TAPPING)		D504	DZN4148---	DIODE	1N4148 AUTO 52MM
C822	CCXB1H101K	C CERA	50V B 100PF K (TAPPING)		D505	DZN4148---	DIODE	1N4148 AUTO 52MM
C823	CCXB1H101K	C CERA	50V B 100PF K (TAPPING)		D507	DGUR460---	DIODE	GUR460
C824	CCXB1H101K	C CERA	50V B 100PF K (TAPPING)		D509	DSDS06F150	DIODE	SDS06F150STU
C825	CCXB2H471K	C CERA	500V B 470PF K (TAPPING)		D510	DSUF1504SP	DIODE	SUF1504SP
C826	CCXF1H104Z	C CERA	50V F 0.1MF Z		D511	85801052GY	WIRE COPPER	1/0.52 TIN COATING
C827	CCXF1H104Z	C CERA	50V F 0.1MF Z		D516	D1N4007---	DIODE	IN4007
C831	CCXF1H104Z	C CERA	50V F 0.1MF Z		D517	D1N4007---	DIODE	IN4007
C833	CCXB1H682K	C CERA	50V B 6800PF K (TAPPING)		D520	DBAV20----	DIODE	BAV20
C861	CCXF1H104Z	C CERA	50V F 0.1MF Z		D560	DRGP10D---	DIODE	RGP 10-D (TAPPING)
C862	CCXF1H104Z	C CERA	50V F 0.1MF Z		D591	DZN4148---	DIODE	1N4148 AUTO 52MM
C863	CCXB1H682K	C CERA	50V B 6800PF K (TAPPING)		D592	DZN4148---	DIODE	1N4148 AUTO 52MM
C864	CCXF1H104Z	C CERA	50V F 0.1MF Z		D593	DZN4148---	DIODE	1N4148 AUTO 52MM
C866	CCXF1H103Z	C CERA	50V F 0.01MF Z (TAPPING)		D594	DZN4148---	DIODE	1N4148 AUTO 52MM
CA200	9970800045	CABLE SIGNAL AS	15P+3C/DDC=1.5M(GY275A)		D601	DRU1P-----	DIODE	RU 1P (TAPPING)
CA201	99707C0011	CONN AS	SMH200-11+YBNH200-12=250		D611	DZN4148---	DIODE	1N4148 AUTO 52MM

LOC	PART-CODE	PART-NAME	PART-DESC	LOC	PART-CODE	PART-NAME	PART-DESC
D612	DRGP10K---	DIODE	RGP10K	Q001	TSP04N60S	FET	SPP04N60S5
D613	DRGP10K---	DIODE	RGP10K	Q002	TZTC3198Y-	TR	KTC3198Y-(1815Y) (AUTO)
D801	DZN4148---	DIODE	1N4148 AUTO 52MM	Q101	TZTA1270Y-	TR	KTA1270Y(AUTO)(562Y)
D802	DZN4148---	DIODE	1N4148 AUTO 52MM	Q102	TZTC3198Y-	TR	KTC3198Y-(1815Y) (AUTO)
D803	DBAV20----	DIODE	BAV20	Q105	TZTC3198Y-	TR	KTC3198Y-(1815Y) (AUTO)
D804	DBAV20----	DIODE	BAV20	Q204	TZSR1009--	TR	KSR1009
D831	DZN4148---	DIODE	1N4148 AUTO 52MM	Q401	TKSD471ACY	TR	KSD471ACY
D832	DZN4148---	DIODE	1N4148 AUTO 52MM	Q501	TZTA1266Y-	TR	KTA1266Y- (AUTO)(1015Y)
D833	DBAV20----	DIODE	BAV20	Q504	TKSC2383Y-	TR	KSC 2383-Y
D834	DBAV20----	DIODE	BAV20	Q505	T2SC5387--	TR H.OUT	2SC5387
D861	DZN4148---	DIODE	1N4148 AUTO 52MM	Q506	TZTC3197--	TR	KTC3197 (AUTO)(388A)
D862	DZN4148---	DIODE	1N4148 AUTO 52MM	Q507	T1RF630A--	FET	IRF630A
D863	DBAV20----	DIODE	BAV20	Q510	TZTC3198Y-	TR	KTC3198Y-(1815Y) (AUTO)
D864	DBAV20----	DIODE	BAV20	Q511	T1RF630A--	FET	IRF630A
△ DG001	5MG0000066	COIL DEGAUSSING	DG-526X	Q512	TZTC3198Y-	TR	KTC3198Y-(1815Y) (AUTO)
DL211	DSD50GYW--	LED	SD50GYW(GREEN/AMBER)	Q513	T1RF630A--	FET	IRF630A
DZ001	DDZ7R5BM--	DIODE ZENER	DZ7.5BM	Q515	TZTA1266Y-	TR	KTA1266Y- (AUTO)(1015Y)
DZ003	DDZ22BM---	DIODE ZENER	DZ22BM	Q516	TZTA1266Y-	TR	KTA1266Y- (AUTO)(1015Y)
DZ006	DDZ15BM---	DIODE ZENER	DZ15BM	Q517	TBD677A---	TR	BD677A
DZ201	DDZ5R1B---	DIODE ZENER	DZ-5.1B	Q560	T2N6520---	TR	2N6520
DZ202	DDZ5R1B---	DIODE ZENER	DZ-5.1B	Q591	TZTA1270Y-	TR	KTA1270Y(AUTO)(562Y)
DZ203	DDZ5R1B---	DIODE ZENER	DZ-5.1B	Q592	TZTC3198Y-	TR	KTC3198Y-(1815Y) (AUTO)
DZ205	DDZ5R1B---	DIODE ZENER	DZ-5.1B	Q610	TZTC3198Y-	TR	KTC3198Y-(1815Y) (AUTO)
DZ206	DDZ5R1B---	DIODE ZENER	DZ-5.1B	Q611	TKSP45----	TR	KSP45
DZ207	DDZ5R1B---	DIODE ZENER	DZ-5.1B	Q612	TKSP45----	TR	KSP45
DZ208	DDZ5R1B---	DIODE ZENER	DZ-5.1B	Q613	TKSP45----	TR	KSP45
DZ212	DDZ5R1B---	DIODE ZENER	DZ-5.1B	Q614	TKSP45----	TR	KSP45
△ F001	5F3CB3122L	FUSE CERA	SEMKO TL 3.15AH 250V MF51	Q615	TZTA1266Y-	TR	KTA1266Y- (AUTO)(1015Y)
GND1	9970710233	CONN AS	HOLDER+1015#18+SOLDER=100	R003	RD-4Z105J-	R CARBON FILM	1/4 1M OHM J
GND2	9970710247	CONN AS	35068+35072+1015#22=160	R004	RS02Z104J-	R M-OXIDE FILM	2W 100K OHM J TAPPING
GND3	9970710247	CONN AS	35068+35072+1015#22=160	R005	RD-AZ102J-	R CARBON FILM	1/6 1K OHM J
△ IC001	1H3842P---	IC POWER	H3842P	R006	RD-AZ564J-	R CARBON FILM	1/6 560K OHM J
IC101	1UTC78L05M	IC REGULATOR	78L05M	R007	RD-AZ912J-	R CARBON FILM	1/6 9.1K OHM J
IC102	1KA78R12--	IC REGULATOR	KA78R12	R008	RD-AZ242J-	R CARBON FILM	1/6 2.4K OHM J
IC201	1DWM240T--	IC MICOM	NT68P62	R009	RS01Z273J-	R M-OXIDE FILM	1W 27K OHM J (TAPPING)
IC202	124C08----	IC EEPROM	24C08	R012	RD-AZ101J-	R CARBON FILM	1/6 100 OHM J
IC204	1DW0SD11--	IC OSD	NT6828-00005	R013	RD-AZ223J-	R CARBON FILM	1/6 22K OHM J
IC401	1KA2142---	IC V-OUT	KA2142	R014	RD-AZ102J-	R CARBON FILM	1/6 1K OHM J
IC501	1TDA4856--	IC H.OSC	TDA4856	R015	RS01Z228J-	R M-OXIDE FILM	1W 0.22 OHM J
IC801	1TDA9210--	IC VIDEO PREAMP	TDA9210	R016	RD-AZ103J-	R CARBON FILM	1/6 10K OHM J
IC802	1TDA9536--	IC VIDEO OUTPUT	TDA9536	R017	RD-AZ563J-	R CARBON FILM	1/6 56K OHM J
L502	5MH0000079	COIL H-LINEARITY	TRL-531X	R018	RD-AZ823J-	R CARBON FILM	1/6 82K OHM J
L503	5MC0000060	COIL CHOKE	TCH-18A	R026	RD-AZ912J-	R CARBON FILM	1/6 9.1K OHM J
L505	5MC0000060	COIL CHOKE	TCH-18A	R104	RD-AZ103J-	R CARBON FILM	1/6 10K OHM J
L801	5CPZ568K02	COIL PEAKING	0.56UH K (AXIAL 3.5MM)	R105	RD-4Z331J-	R CARBON FILM	1/4 330 OHM J
L831	5CPZ338K02	COIL PEAKING	0.33UH K (AXIAL 3.5MM)	R107	RD-AZ472J-	R CARBON FILM	1/6 4.7K OHM J
L861	5CPZ568K02	COIL PEAKING	0.56UH K (AXIAL 3.5MM)	R110	RD-2Z100J-	R CARBON FILM	1/2 10 OHM J
△ P001	9979500024	RECEPTACLE	02ME4E3P/FILTER EMI	R111	RD-2Z100J-	R CARBON FILM	1/2 10 OHM J
△ PR001	DECPAC140M	POSISTOR	ECPAC140M290	R112	RD-AZ102J-	R CARBON FILM	1/6 1K OHM J

LOC	PART-CODE	PART-NAME	PART-DESC
R113	RD-AZ562J	R CARBON FILM	1/6 5.6K OHM J
R202	RD-AZ101J	R CARBON FILM	1/6 100 OHM J
R203	RD-AZ101J	R CARBON FILM	1/6 100 OHM J
R204	RD-AZ202J	R CARBON FILM	1/6 2K OHM J
R205	RD-AZ101J	R CARBON FILM	1/6 100 OHM J
R206	RD-AZ101J	R CARBON FILM	1/6 100 OHM J
R207	RD-AZ103J	R CARBON FILM	1/6 10K OHM J
R208	RD-AZ105J	R CARBON FILM	1/6 1M OHM J
R209	RD-AZ562J	R CARBON FILM	1/6 5.6K OHM J
R210	RD-AZ562J	R CARBON FILM	1/6 5.6K OHM J
R211	RD-AZ153J	R CARBON FILM	1/6 15K OHM J
R212	RD-AZ433J	R CARBON FILM	1/6 43K OHM J
R213	RD-AZ203J	R CARBON FILM	1/6 20K OHM J
R214	RD-AZ103J	R CARBON FILM	1/6 10K OHM J
R215	RD-AZ153J	R CARBON FILM	1/6 15K OHM J
R216	RD-AZ433J	R CARBON FILM	1/6 43K OHM J
R217	RD-AZ203J	R CARBON FILM	1/6 20K OHM J
R218	RD-AZ202J	R CARBON FILM	1/6 2K OHM J
R219	RD-AZ152J	R CARBON FILM	1/6 1.5K OHM J
R220	RD-AZ152J	R CARBON FILM	1/6 1.5K OHM J
R221	RD-AZ391J	R CARBON FILM	1/6 390 OHM J
R223	RD-AZ101J	R CARBON FILM	1/6 100 OHM J
R224	RD-AZ202J	R CARBON FILM	1/6 2K OHM J
R225	RD-AZ101J	R CARBON FILM	1/6 100 OHM J
R226	RD-AZ202J	R CARBON FILM	1/6 2K OHM J
R228	RD-AZ391J	R CARBON FILM	1/6 390 OHM J
R231	RD-AZ274J	R CARBON FILM	1/6 270K OHM J
R232	RD-AZ223J	R CARBON FILM	1/6 22K OHM J
R233	RD-AZ202J	R CARBON FILM	1/6 2K OHM J
R234	RD-AZ122J	R CARBON FILM	1/6 1.2K OHM J
R237	RD-AZ101J	R CARBON FILM	1/6 100 OHM J
R240	RD-AZ101J	R CARBON FILM	1/6 100 OHM J
R250	RD-AZ101J	R CARBON FILM	1/6 100 OHM J
R251	RD-AZ101J	R CARBON FILM	1/6 100 OHM J
R252	RD-AZ511J	R CARBON FILM	1/6 510 OHM J
R253	RD-AZ562J	R CARBON FILM	1/6 5.6K OHM J
R254	85801052GY	WIRE COPPER	1/0.52 TIN COATING
R255	RD-AZ562J	R CARBON FILM	1/6 5.6K OHM J
R256	RD-AZ105J	R CARBON FILM	1/6 1M OHM J
R257	RD-AZ511J	R CARBON FILM	1/6 510 OHM J
R258	RD-AZ563J	R CARBON FILM	1/6 56K OHM J
R260	RD-AZ362J	R CARBON FILM	1/6 3.6K OHM J
R262	RD-AZ101J	R CARBON FILM	1/6 100 OHM J
R263	RD-AZ101J	R CARBON FILM	1/6 100 OHM J
R264	RD-AZ101J	R CARBON FILM	1/6 100 OHM J
R401	RD-AZ223J	R CARBON FILM	1/6 22K OHM J
R402	RD-AZ512J	R CARBON FILM	1/6 5.1K OHM J
R403	RD-AZ101J	R CARBON FILM	1/6 100 OHM J
R404	RD-AZ101J	R CARBON FILM	1/6 100 OHM J

LOC	PART-CODE	PART-NAME	PART-DESC
R410	RD-AZ682J	R CARBON FILM	1/6 6.8K OHM J
R411	RD-AZ682J	R CARBON FILM	1/6 6.8K OHM J
R412	RD-AZ562J	R CARBON FILM	1/6 5.6K OHM J
R413	RD-AZ682J	R CARBON FILM	1/6 6.8K OHM J
R414	RD-AZ682J	R CARBON FILM	1/6 6.8K OHM J
R415	RD-2Z109J	R CARBON FILM	1/2 1 OHM J
R416	RD-AZ562J	R CARBON FILM	1/6 5.6K OHM J
R417	RD-2Z309J	R CARBON FILM	1/2 3 OHM J
R418	RD-2Z339J	R CARBON FILM	1/2 3.3 OHM J
R420	RD-AZ472J	R CARBON FILM	1/6 4.7K OHM J
R421	RD-AZ562J	R CARBON FILM	1/6 5.6K OHM J
R422	RD-AZ303J	R CARBON FILM	1/6 30K OHM J
R426	RD-AZ103J	R CARBON FILM	1/6 10K OHM J
R427	RD-AZ202J	R CARBON FILM	1/6 2K OHM J
R500	RD-AZ393J	R CARBON FILM	1/6 39K OHM J
R501	RD-AZ302J	R CARBON FILM	1/6 3K OHM J
R502	RD-AZ332J	R CARBON FILM	1/6 3.3K OHM J
R504	RD-AZ103J	R CARBON FILM	1/6 10K OHM J
R506	RD-AZ471J	R CARBON FILM	1/6 470 OHM J
R507	RD-AZ122J	R CARBON FILM	1/6 1.2K OHM J
R508	RD-AZ222J	R CARBON FILM	1/6 2.2K OHM J
R510	RD-AZ473J	R CARBON FILM	1/6 47K OHM J
R511	RN-AZ2741F	R METAL FILM	1/6 2.74K OHM F
R512	RN-AZ1211F	R METAL FILM	1/6 1.21K OHM F
R513	RD-AZ332J	R CARBON FILM	1/6 3.3K OHM J
R514	RD-AZ512J	R CARBON FILM	1/6 5.1K OHM J
R515	RD-AZ472J	R CARBON FILM	1/6 4.7K OHM J
R516	RD-AZ332J	R CARBON FILM	1/6 3.3K OHM J
R517	RD-AZ153J	R CARBON FILM	1/6 15K OHM J
R520	RD-2Z121J	R CARBON FILM	1/2 120 OHM J
R521	RD-AZ220J	R CARBON FILM	1/6 22 OHM J
R522	RD-AZ223J	R CARBON FILM	1/6 22K OHM J
R523	RD-AZ563J	R CARBON FILM	1/6 56K OHM J
R524	RD-2Z121J	R CARBON FILM	1/2 120 OHM J
R525	RD-2Z121J	R CARBON FILM	1/2 120 OHM J
R526	RD-2Z221J	R CARBON FILM	1/2 220 OHM J
R527	RD-AZ102J	R CARBON FILM	1/6 1K OHM J
R528	RD-AZ223J	R CARBON FILM	1/6 22K OHM J
R529	RD-2Z229J	R CARBON FILM	1/2 2.2 OHM J
R530	RD-2Z221J	R CARBON FILM	1/2 220 OHM J
R533	RD-AZ513J	R CARBON FILM	1/6 51K OHM J
R534	RD-AZ153J	R CARBON FILM	1/6 15K OHM J
R535	RD-AZ182J	R CARBON FILM	1/6 1.8K OHM J
R536	RD-AZ105J	R CARBON FILM	1/6 1M OHM J
R537	RD-AZ153J	R CARBON FILM	1/6 15K OHM J
R538	RD-AZ182J	R CARBON FILM	1/6 1.8K OHM J
R541	RD-AZ102J	R CARBON FILM	1/6 1K OHM J
R543	RD-AZ912J	R CARBON FILM	1/6 9.1K OHM J
R544	RD-AZ391J	R CARBON FILM	1/6 390 OHM J

LOC	PART-CODE	PART-NAME	PART-DESC	LOC	PART-CODE	PART-NAME	PART-DESC
R545	RD-AZ471J-	R CARBON FILM	1/6 470 OHM J	R802	RD-AZ330J-	R CARBON FILM	1/6 33 OHM J
R547	RS01Z688J-	R M-OXIDE FILM	1W 0.68 OHM J	R803	RD-AZ360J-	R CARBON FILM	1/6 36 OHM J
R548	DTVR1G----	DIODE	TVR1G TPA1	R804	RD-4Z121J-	R CARBON FILM	1/4 120 OHM J
R549	RD-AZ153J-	R CARBON FILM	1/6 15K OHM J	R805	RD-4Z121J-	R CARBON FILM	1/4 120 OHM J
R550	RD-AZ154J-	R CARBON FILM	1/6 150K OHM J	R811	RD-AZ101J-	R CARBON FILM	1/6 100 OHM J
R551	RD-AZ154J-	R CARBON FILM	1/6 150K OHM J	R812	RD-AZ279J-	R CARBON FILM	1/6 2.7 OHM J
R553	RD-2Z758J-	R CARBON FILM	1/2 0.75 OHM J	R813	RD-AZ279J-	R CARBON FILM	1/6 2.7 OHM J
R554	RS01Z102J-	R M-OXIDE FILM	1W 1K OHM J (TAPPING)	R815	RD-4Z562J-	R CARBON FILM	1/4 5.6K OHM J
R555	RD-4Z104J-	R CARBON FILM	1/4 100K OHM J	R816	RD-4Z564J-	R CARBON FILM	1/4 560K OHM J
R556	RD-AZ562J-	R CARBON FILM	1/6 5.6K OHM J	R817	RD-2Z228J-	R CARBON FILM	1/2 0.22 OHM J
R560	RD-AZ913J-	R CARBON FILM	1/6 91K OHM J	R831	RD-AZ750J-	R CARBON FILM	1/6 75 OHM J
R562	RD-AZ393J-	R CARBON FILM	1/6 39K OHM J	R832	RD-AZ330J-	R CARBON FILM	1/6 33 OHM J
R563	RN-AZ2701F	R METAL FILM	1/6 2.7K OHM F	R833	RD-AZ360J-	R CARBON FILM	1/6 36 OHM J
R564	RD-AZ302J-	R CARBON FILM	1/6 3K OHM J	R834	RD-4Z121J-	R CARBON FILM	1/4 120 OHM J
R572	RD-4Z473J-	R CARBON FILM	1/4 47K OHM J	R835	RD-4Z121J-	R CARBON FILM	1/4 120 OHM J
R574	RD-4Z473J-	R CARBON FILM	1/4 47K OHM J	R841	RD-AZ101J-	R CARBON FILM	1/6 100 OHM J
R578	RD-2Z758J-	R CARBON FILM	1/2 0.75 OHM J	R861	RD-AZ750J-	R CARBON FILM	1/6 75 OHM J
R580	RD-AZ824J-	R CARBON FILM	1/6 820K OHM J	R862	RD-AZ330J-	R CARBON FILM	1/6 33 OHM J
R589	RD-AZ822J-	R CARBON FILM	1/6 8.2K OHM J	R863	RD-AZ360J-	R CARBON FILM	1/6 36 OHM J
R591	RD-AZ103J-	R CARBON FILM	1/6 10K OHM J	R864	RD-4Z121J-	R CARBON FILM	1/4 120 OHM J
R592	RD-AZ152J-	R CARBON FILM	1/6 1.5K OHM J	R865	RD-4Z121J-	R CARBON FILM	1/4 120 OHM J
R594	RD-AZ102J-	R CARBON FILM	1/6 1K OHM J	R871	RD-AZ101J-	R CARBON FILM	1/6 100 OHM J
R595	RD-AZ273J-	R CARBON FILM	1/6 27K OHM J	△ RL001	5SC0101325	SW RELAY	HR-CR7 DC12V
R596	RD-AZ104J-	R CARBON FILM	1/6 100K OHM J	SG610	4SG0D00104	SPARK GAP	S-23 1.5KV
R597	RD-AZ104J-	R CARBON FILM	1/6 100K OHM J	SG801	DWSP201M--	SURGE ABSORBER	WSP-201M
R598	RD-AZ183J-	R CARBON FILM	1/6 18K OHM J	SG811	4SG0D00104	SPARK GAP	S-23 1.5KV
R610	RD-AZ182J-	R CARBON FILM	1/6 1.8K OHM J	SG831	DWSP201M--	SURGE ABSORBER	WSP-201M
R611	RD-AZ472J-	R CARBON FILM	1/6 4.7K OHM J	SG861	DWSP201M--	SURGE ABSORBER	WSP-201M
R612	RD-AZ100J-	R CARBON FILM	1/6 10 OHM J	SW201	5S50101Z01	SW TACT	KPT-1115VM 1C-1P
R613	RD-AZ244J-	R CARBON FILM	1/6 240K OHM J	SW202	5S50101Z01	SW TACT	KPT-1115VM 1C-1P
R614	RD-AZ433J-	R CARBON FILM	1/6 43K OHM J	SW203	5S50101Z01	SW TACT	KPT-1115VM 1C-1P
R615	RD-AZ754J-	R CARBON FILM	1/6 750K OHM J	SW204	5S50101Z01	SW TACT	KPT-1115VM 1C-1P
R616	RD-AZ624J-	R CARBON FILM	1/6 620K OHM J	SW205	5S50101Z01	SW TACT	KPT-1115VM 1C-1P
R617	RD-2Z184J-	R CARBON FILM	1/2 180K OHM J	SW206	5S50101Z01	SW TACT	KPT-1115VM 1C-1P
R618	RD-2Z184J-	R CARBON FILM	1/2 180K OHM J	△ T001	5RM0000103	TRANS SMPS	DMT-531X
R619	RD-2Z822J-	R CARBON FILM	1/2 8.2K OHM J	△ T500	5RH0000129	FBT	CF1656
R620	RD-2Z102J-	R CARBON FILM	1/2 1K OHM J	T501	5RD0000052	TRANS DRIVE	DDT-531X
R621	RD-AZ473J-	R CARBON FILM	1/6 47K OHM J	TH001	DTP8D13---	THERMISTOR	TP8D13
R623	RD-4Z472J-	R CARBON FILM	1/4 4.7K OHM J	VR001	RV6121202P	R SEMI FIXED	CCT 063BT 2K OHM B TAP
R624	RD-AZ133J-	R CARBON FILM	1/6 13K OHM J	VR501	RV6121102P	R SEMI FIXED	CCT 063BT 1K OHM B TAP
R625	RD-AZ822J-	R CARBON FILM	1/6 8.2K OHM J	X201	5PEF0EC8T4	RESONATOR	EFOEC8004T4
R801	RD-AZ750J-	R CARBON FILM	1/6 75 OHM J				

DAEWOO

DAEWOO ELECTRONICS CO., LTD

686, AHYEON-DONG MAPO-GU
SEOUL, KOREA

C.P.O. BOX 8003 SEOUL, KOREA

TELEX : DWELEC K28177-8

CABLE : "DAEWOOELEC"

E-mail : G7F00E@web.dwe.co.kr

TEL : 82-32-510-7620

FAX : 82-32-510-7630