

NOTE: -ALL RESISTORS 1/4 WATT
 -ALL CAPACITORS IN μ F UNLESS NOTED

PLUG J1

PLUG J3

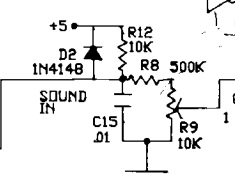
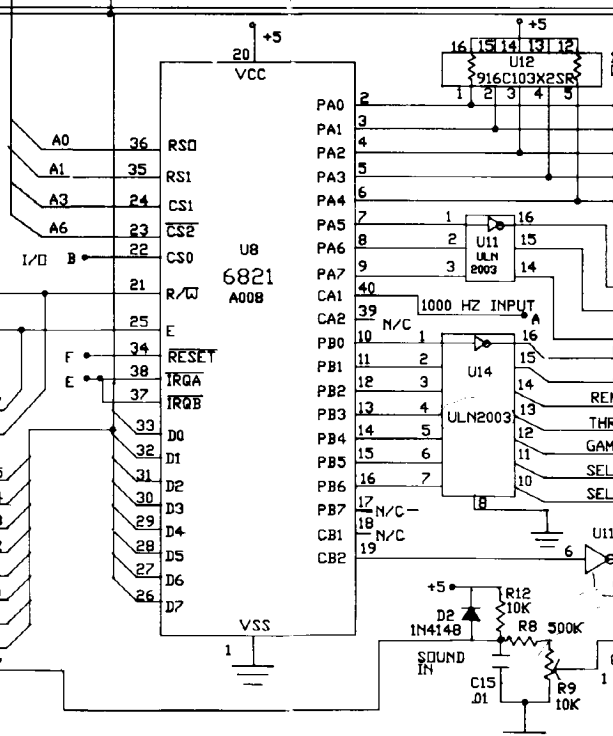
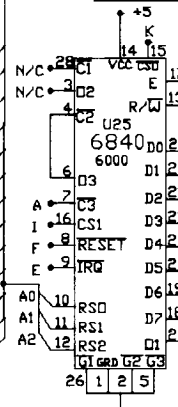
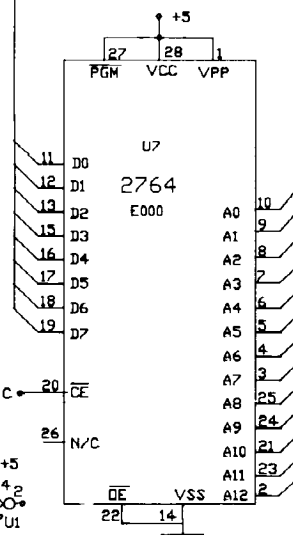
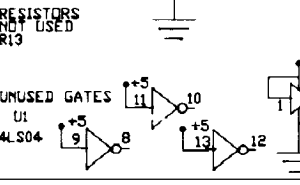
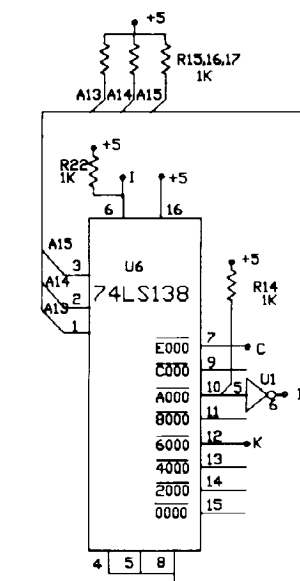
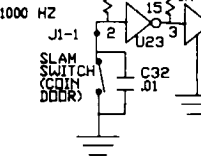
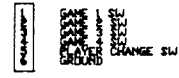
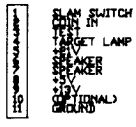
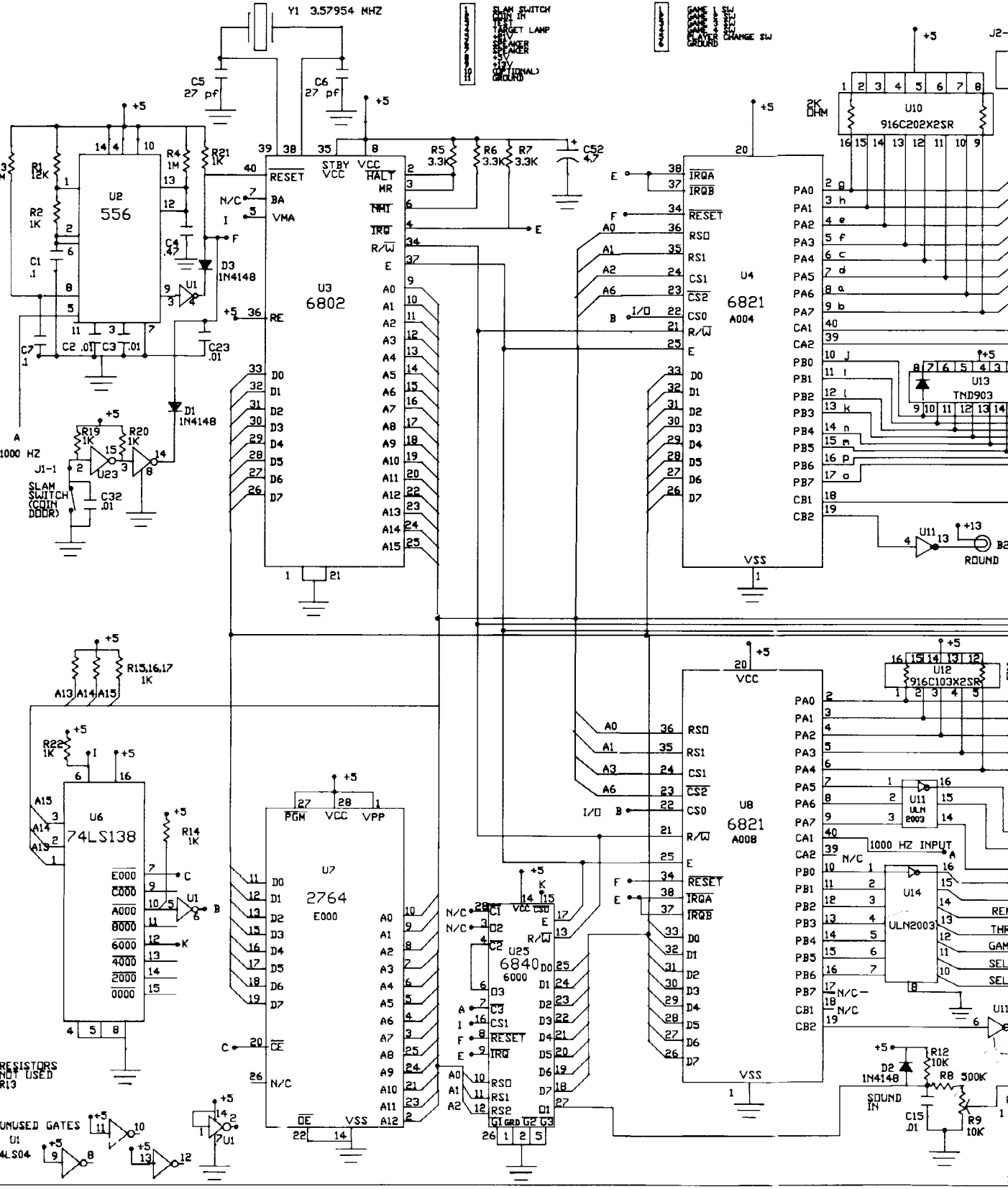

RESISTORS NOT USED R13

UNUSED GATES U1

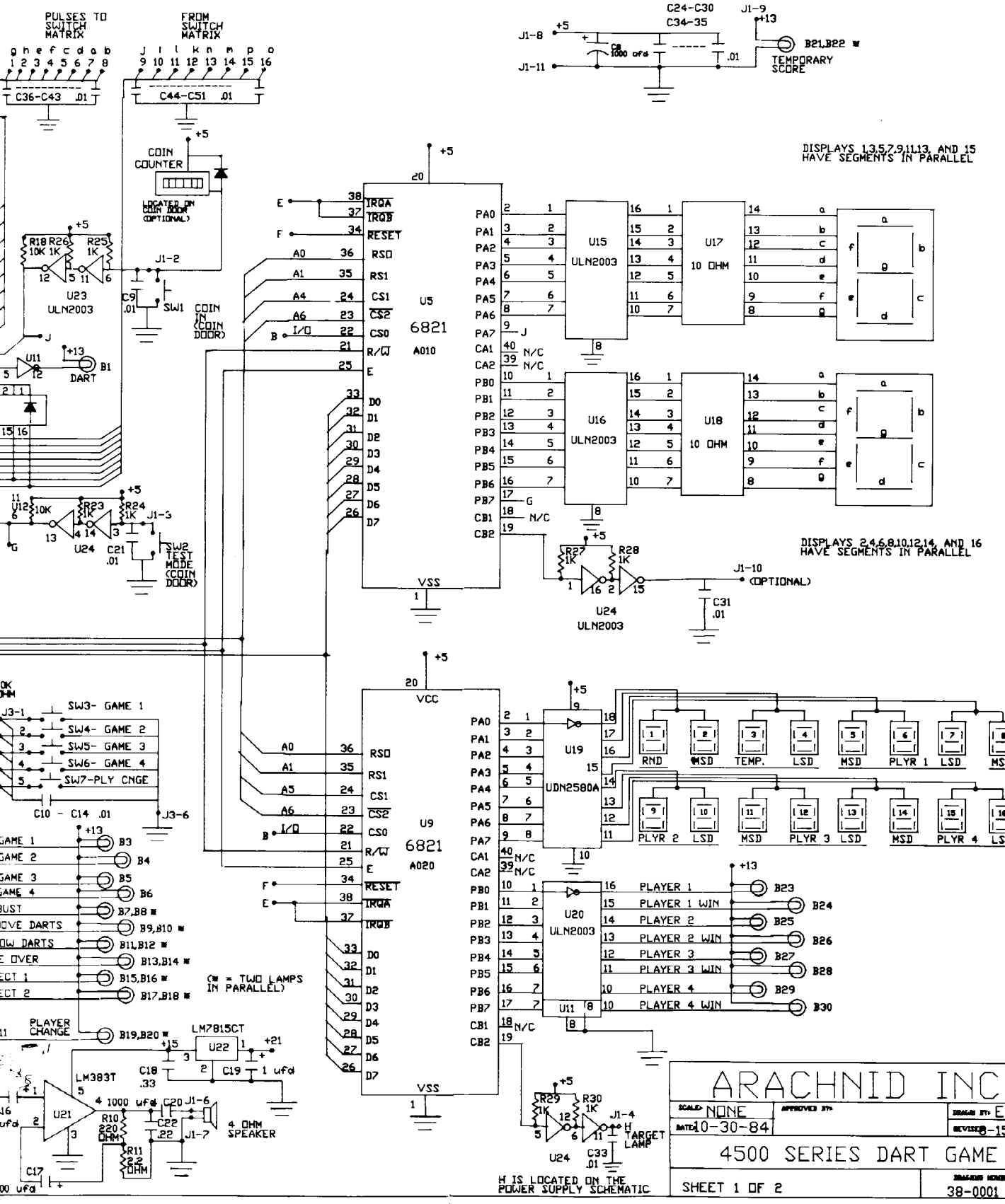

DISPLAYS 1,3,5,7,9,11,13, AND 15 HAVE SEGMENTS IN PARALLEL

DISPLAYS 2,4,6,8,10,12,14, AND 16 HAVE SEGMENTS IN PARALLEL

(= = TWO LAMPS IN PARALLEL)

ARACHNID INC.

SCALE: NONE	APPROVED BY:	DRAWN BY: E
DATE: 10-30-84		REVISED: -15
4500 SERIES DART GAME		
SHEET 1 OF 2		ARACHNID NUMBER 38-0001

H IS LOCATED ON THE POWER SUPPLY SCHEMATIC

POWER SUPPLY CHASSIS

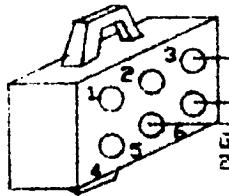

3 MALE PINS
10-0016

VIOLET - 43"

GREEN
21", 18ga

TO COIN DOOR
10-0060 MALE CONN.

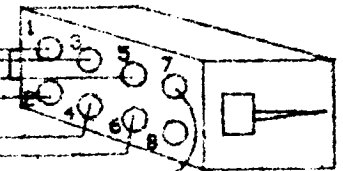

7 FEMALE PINS
10-0015

FEMALE CONN.
10-0007

WIRES INSERTED
LATER INTO
PS CONN. ABOVE
PIN 1 - BLACK
PIN 2 - GREY
PIN 3 - WHITE

ALL WIRE 20ga
EXCEPT AS NOTED

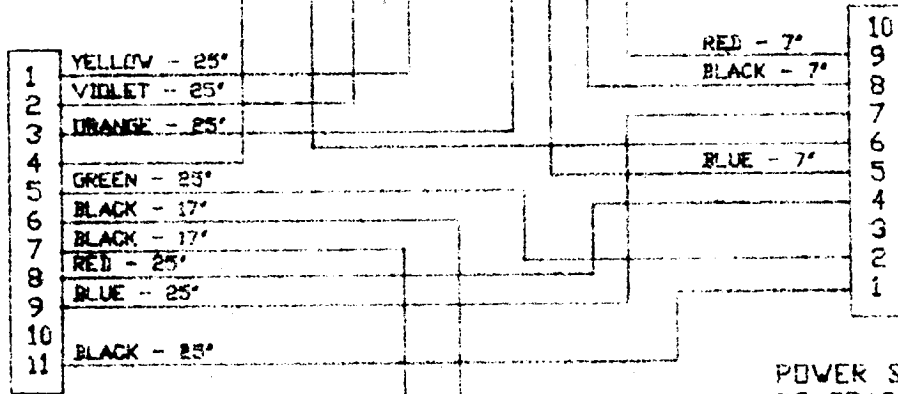

MAIN BOARD CONN.
10-0055

POWER SUPPLY
PC BOARD CONN.
10-0028



SPEAKER
10-0005 MALE CONN.
2 FEMALE PINS
10-0015

CHANGE	DATE	ECN
REVISION		

Arachnid

6421 Material Avenue • Rockford, Illinois 61132

DWG. NO. 00-4500-08

DRAWN BY E.G.H.	DATE 1-31-86	CHECKED BY	DATE
MATERIAL (CPU FILE 4500-08)			SCALE NONE

NAME POWER SUPPLY HARNESS

SHEET OF

DWG. NO. 00-4500-23

ALL WIRE 20 ga UNLESS NOTED

MALE CONN 10-0009
POWER SUPPLY
CHASSIS MOUNT

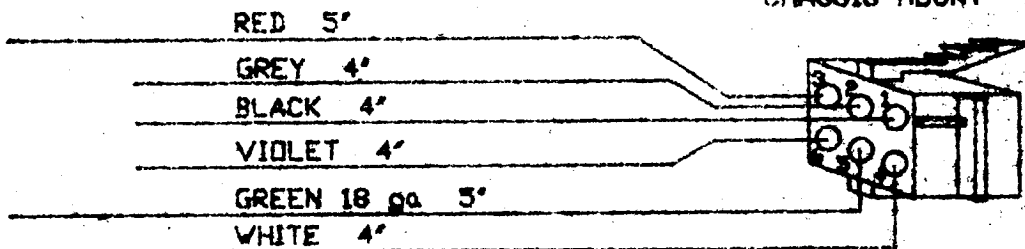

ALL WIRE ENDS STRIPPED

6 FEMALE PINS
10-0015

FUSE HOLDER 13-0039

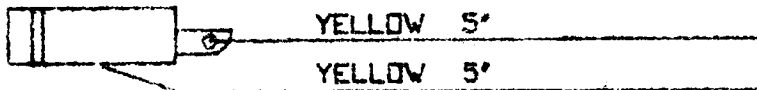

ON/OFF SWITCH 08-0004



Arachnid

6421 Material Avenue • Rockford, Illinois 61102

DWG. NO. 00-4500-23

CHANGE

DATE

ECN

DRAWN BY ECH

DATE 1-31-86

CHECKED BY

DATE

REVISION

MATERIAL

CPU 4500-B3

SCALE

NAME

BLACK COIN DOOR HARNESS

SHEET
OF

DWG. NO. 00-4500-11

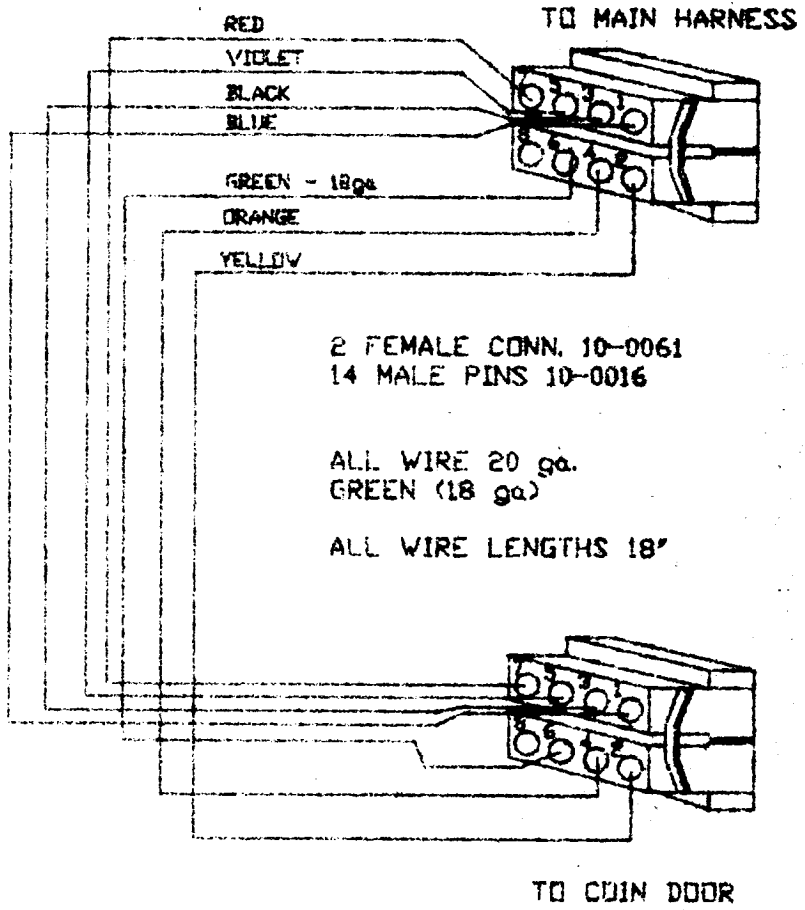

CHANGE	DATE	ECN
REVISION		

Arachnid

6421 Material Avenue • Rockford, Illinois 61132

DWG. NO. 00-4500-11

DRAWN BY LJS	DATE 1-31-85	CHECKED BY	DATE
MATERIAL CPU 4500-11			SCALE NONE

NAME

WIRNESS, COIN DDDIG 4500

SHEET
OF

DWG. NO. 00-4500-10

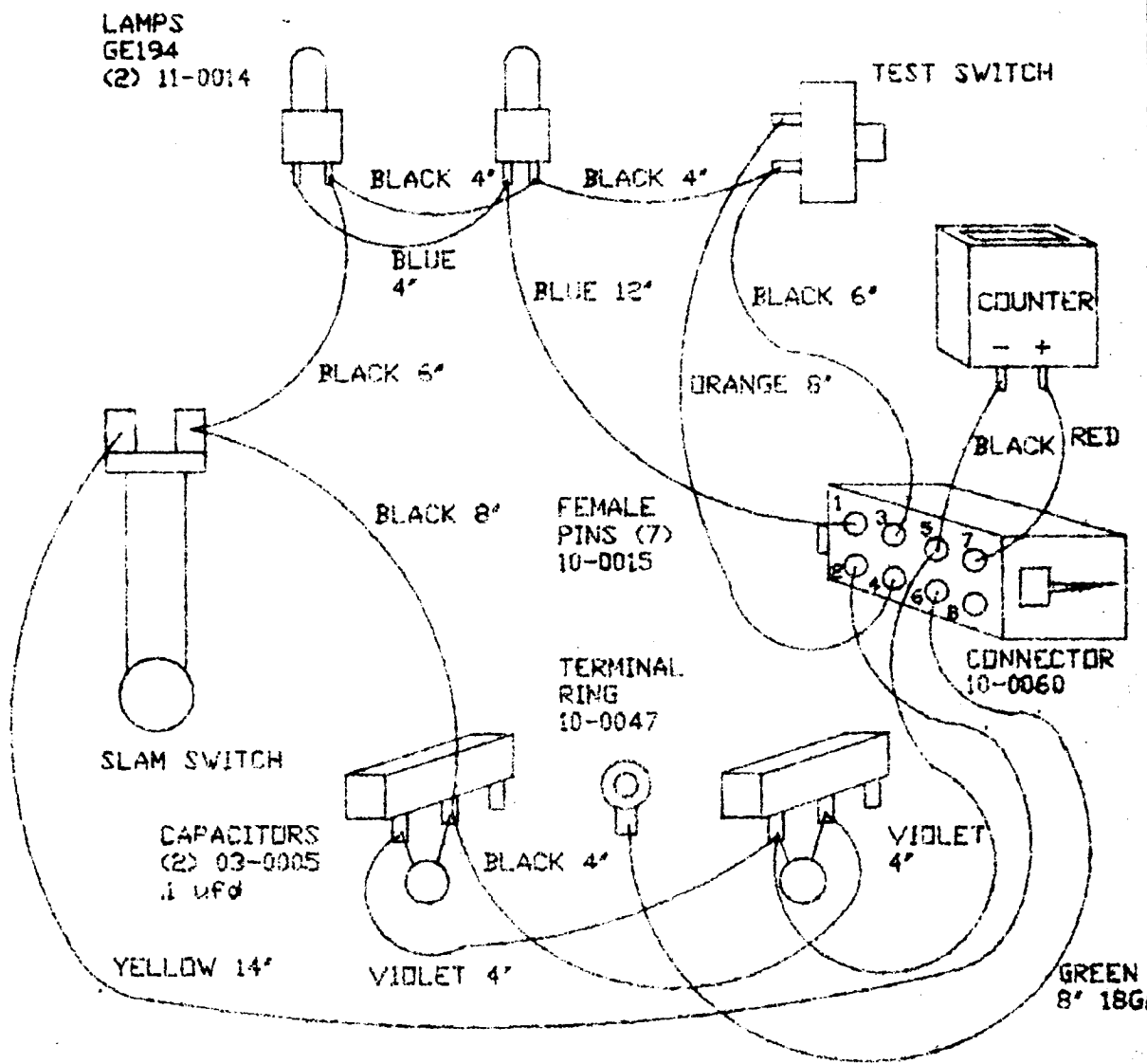

CHANGE	DATE	ECN
REVISION		

Arachnid

6421 Material Avenue • Rockford, Illinois 61132

DWG. NO. 00-4500-10

DRAWN BY E.C.H.	DATE 2-26-86	CHECKED BY	DATE
MATERIAL CPU DRAWING # 4500-10			SCALE NONE