



Series Operator's Manual



The Originator of Electronic Darts

6212 Material Avenue
Loves Park, Illinois 61111
815-654-0212 or 800-435-8319

www.arachnidinc.com
P/N 42850 Rev. B
Software Version 243



Arachnid Limited Warranty for the Super Shuffle Shuffleboard

Arachnid, Inc., thoroughly inspects and tests all products before they leave the facility and is therefore not responsible for any damages occurred during shipping. Report any damage, whether hidden or obvious, to the shipping company immediately and resolve it through them.

1. Definitions:

As used herein, the term "Buyer" shall mean the purchaser of the goods, the term "Goods" shall mean all Super Shuffle shuffleboard products, equipment, accessories and any labor and services ordered by Buyer from Arachnid.

2. Warranty:

During the warranty period, which is ninety (90) days for the Electronic Package and Cabinet, six (6) months on the 28" Flat Screen Monitor and one (1) year for the Hard Drive and Puck Return Belt, Arachnid will repair or replace at its plant in Loves Park, Illinois, any part of the Goods, which part has been manufactured by Arachnid, and which Arachnid determines to have failed because of defective design, material or workmanship under normal use and service. "Electronic Package" means only (i) the power supply chassis and the parts mounted directly thereon, (ii) the main computer printed circuit board, and the IOB. Arachnid shall have no warranty or other liability for any part not manufactured by it, but agrees to cooperate with Buyer in obtaining an assignment of Arachnid's warranty rights against the manufacturer. Prior to repair or replacement, Arachnid shall have the right to examine the part at its option either at Buyer's location or at Arachnid's plant in Loves Park, Illinois. For this warranty to apply, Buyer must give Arachnid written notice of any warranted defect within fifteen (15) days after discovery and, in any event, not later than the date on which this warranty expires, or Buyer will be barred from any remedy. Upon Arachnid's written authorization, the Goods must be shipped to Arachnid freight prepaid within a reasonable time thereafter. This warranty shall not apply to any of the Goods or parts thereof repaired or altered by anyone but Arachnid, operated or installed contrary to instructions, subjected to misuse, negligence, vandalism, accident, fire or water damage and improper or faulty electrical power source. This warranty is not assignable and expires upon the earlier of Buyer's transfer, sale or other disposition of the Goods, or one (1) year from the date of shipment of the Goods by Arachnid to Buyer. Arachnid's liability under this warranty shall be limited to repairing or replacing warranted Goods or, if such Goods cannot be repaired or replaced by Arachnid, to the return of the purchase price paid for the defective or nonconforming warranted Goods; provided, that Buyer shall first return to Arachnid those goods for which a refund of the purchase price is to be made.

THE WARRANTIES PRINTED ABOVE ARE THE ONLY WARRANTIES APPLICABLE TO THE GOODS. ALL OTHER WARRANTIES, EXPRESSED OR IMPLIED, INCLUDING BUT NOT LIMITED TO THE IMPLIED WARRANTIES OF MERCHANTABILITY AND FITNESS FOR A PARTICULAR PURPOSE, ARE DISCLAIMED.

4. Limitation of Liability

ARACHNID SHALL NOT BE LIABLE, WHETHER IN CONTRACT, IN TORT, UNDER ANY WARRANTY, IN NEGLIGENCE, OR OTHERWISE, FOR INCIDENTAL, CONSEQUENTIAL OR SPECIAL DAMAGES OR FOR COSTS OF REMOVAL OR SHIPMENT. UNDER NO CIRCUMSTANCES SHALL ARACHNID'S LIABILITY OR BUYER'S REMEDY FOR DAMAGES AGAINST ARACHNID EXCEED THE AMOUNT OF THE PURCHASE PRICE OF GOODS SOLD FOR WHICH OR RELATING TO WHICH CLAIM IS MADE. IN THE EVENT THAT ARACHNID'S WARRANTY, IF ANY, OR ANY OTHER OBLIGATION OF ARACHNID APPLICABLE TO THE GOODS FAILS OF ITS ESSENTIAL PURPOSE, BUYER'S EXCLUSIVE REMEDY SHALL BE LIMITED TO RETURN OF OR CREDIT FOR SO MUCH OF THE PURCHASE PRICE AS IS APPLICABLE TO THE GOODS WHICH ARE NONCONFORMING OR DEFECTIVE, PROVIDED SUCH GOODS ARE RETURNED TO ARACHNID. THE PRICE STATED FOR THE GOODS, AS SHOWN IN THE ORIGINAL INVOICE, IS BASED UPON AND IN CONSIDERATION FOR LIMITING ARACHNID'S LIABILITY. NO ACTION ARISING OUT OF THE GOODS MAY BE BROUGHT BY BUYER MORE THAN FIFTEEN (15) MONTHS AFTER THE DATE OF SHIPMENT OF THE GOODS BY ARACHNID TO BUYER. BUYER'S REMEDIES AS PROVIDED HEREIN ARE ITS SOLE AND EXCLUSIVE REMEDIES.



Table of Contents

| | |
|-------------------------------------------|-----------|
| Introduction | 1 |
| Section 1: General Description | 1 |
| 1.1 Dimensions | 1 |
| Section 2: Features of the Machine | 1 |
| Section 3: Super Shuffle Basics | 2 |
| 3.1 Super Shuffle Definitions | 2 |
| 3.2 Using the Console | 2 |
| 3.3 Using the Tournament Mode | 2 |
| Section 4: Operation | 3 |
| 4.1 Power Up | 3 |
| 4.2 Main Game Menu | 3 |
| 4.3 Setup Mode | 4 |
| Section 5: Technical Description | 6 |
| 5.1 Monitor | 6 |
| 5.2 Power Supply | 6 |
| 5.3 Hardware | 6 |
| 5.4 Operating Conditions at 120VAC | 6 |
| Section 6: Communications | 6 |
| 6.1 Setting up a Wired Network | 6 |
| 6.2 Setting up a Wireless Network | 6 |
| 6.3 Manually Setting up your Network | 7 |
| Section 7: Maintenance | 7 |
| 7.1 Adjusting the Lasers | 7 |
| 7.2 Replacing the Laser Mount Brackets | 8 |
| 7.3 Replacing the Sensor Module | 8 |
| 7.4 Opening the Playing Surface | 9 |
| 7.5 Installing a Dollar Bill Acceptor | 9 |
| 7.6 Puck Maintenance | 10 |
| 7.7 Playing Surface Maintenance | 10 |
| Section 8: Service Menu | 10 |
| 8.1 Activating the Service Menu | 10 |
| 8.2 Accessing the Service Menu | 10 |
| 8.3 Using the Reports | 10 |
| Section 9: Parts List | 11 |
| Section 10: Troubleshooting | 13 |

The most current version of this manual is always available on the Arachnid website at: <http://www.arachnidinc.com>

Note: This equipment has been tested and found to comply with the limits for a Class A digital device, pursuant to part 15 of the FCC Rules. These limits are designed to provide reasonable protection against harmful interference when the equipment is operated in a commercial environment. This equipment generates, uses, and can radiate radio frequency energy and, if not installed and used in accordance with the instruction manual, may cause harmful interference to radio communications. Operation of this equipment in a residential area is likely to cause harmful interference in which case the user will be required to correct the interference at his own expense.

This product is not intended for outdoor use. Indoor use only!

Do not install in an area where a water jet may be used.

Introduction

This manual contains operation, parts lists and troubleshooting information for Arachnid's Super Shuffle shuffleboard machine.

If you encounter a problem that is not covered in this manual, or if you have any questions, contact Arachnid at 1-800-435-8319 (815-654-0212) from 8 a.m. to 5 p.m. CST. You can also reach us at arachtech@bullshooter.com or visit our support site at <http://www.arachnidinc.com/support.php>

Section 1 General Description

The Super Shuffle is an electronic shuffleboard.

1.1 Dimensions

Weight Boxed: 225 LBS

Weight Unboxed: 190 LBS

Boxed Dimensions: 69x32x40

Game Height: 53"

Game Width: 31"

Game Depth: 65"

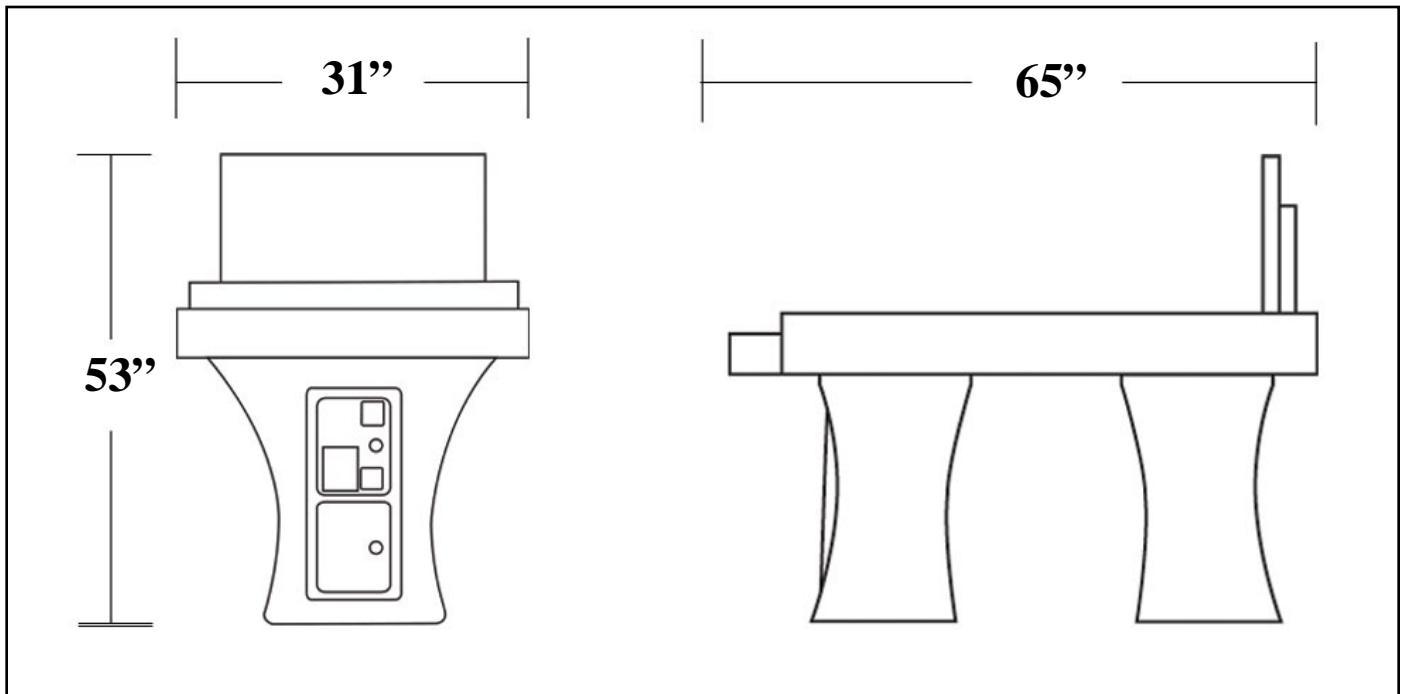

Section 2 Features of the Machine

This section lists the features available on the machine.

A. LCD Flat Screen Monitor

The color graphics on the 28" LCD Flat screen monitor look fantastic.

B. All coin and credit settings are "software selectable." Free Play is also available.

The selection of coins (1 - 20) and the number of credits (1 - 50) allows a wide variety of coin-up options. Both these settings and a "Free Play" option are available in the test/setup mode. "Free Play" will not be reset when the board is rebooted, it must be toggled off. However, it will be reset when the Factory Defaults are reset.

C. Normal Game Play Statistics

The machine displays player statistics on the screen following the end of every game.

D. Operator Reports

Game popularity and coin slot reports are available in the test/setup mode.

E. Online League Play

Shuffleboard leagues are now easier than ever. Stats are stored on the machine and can be downloaded into LeagueLeader.

Section 3 Super Shuffle Basics

3.1 Basic Super Shuffle Definitions

28" Widescreen Monitor - A 28" widescreen HD Monitor.

Playing Field - Players slide their pucks down the playing field.

Gutter - When a puck slides off (or is knocked off) the playing field, the pucks land here.

Drink Holders - Place your frosty beverages in these while you play.

Base - These plastic bases support the Super Shuffle and contain the coin mechanisms.

Levelers- Allows for adjustment on uneven floors.

3.2 Using the Console

The console contains three (3) buttons; Up, Down and Enter. These three buttons are used to navigate the menus on the Super Shuffle. They also have uses while playing a game.

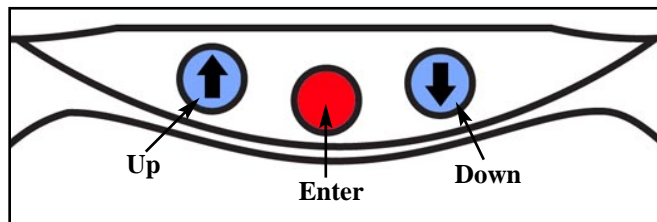

During a game, you can use the Console buttons to view the playing field.

♦Pressing the Blue "Up" Button will give you an overhead view of the playing field on the monitor.

♦Pressing the Blue "Down" button will display the end of the playing field on the monitor.

♦Pressing the Red "Enter" Button will display the menu page. From here you can exit the game or view instructions.

3.3 Using the Tournament Mode

Want to run a local/inhouse tournament? The Super Shuffle has a tournament program built in. This plays between 3 and 8 people and is single elimination. Follow the instructions below to set up a mini tournament.

1. From the main menu, select Tournament.
2. Select the game you will play. Knock Off 11, Knock Off 15, Crazy Shuffle, Classic Bowling, Classic Bowling Pro, Split/Second and Split/Second Pro Bowling are available in tournament mode.
3. Select the number of players playing in the tournament.
4. Choose to randomize the chart or not.
 - a. Selecting YES will mix up the playing order.
 - b. Selecting NO will use a default tournament chart.
5. Enter the player names. You will use the arrows to highlight the letters and the red button to select them. The letters are arranged alphabetically.
6. Choose **Start Tournament** to begin the tournament. The next page will display the tournament chart. Press the red button to continue. The first match will be brought up to be played.
7. Players will then need to insert enough money to play the game. Choose **Start Match**.

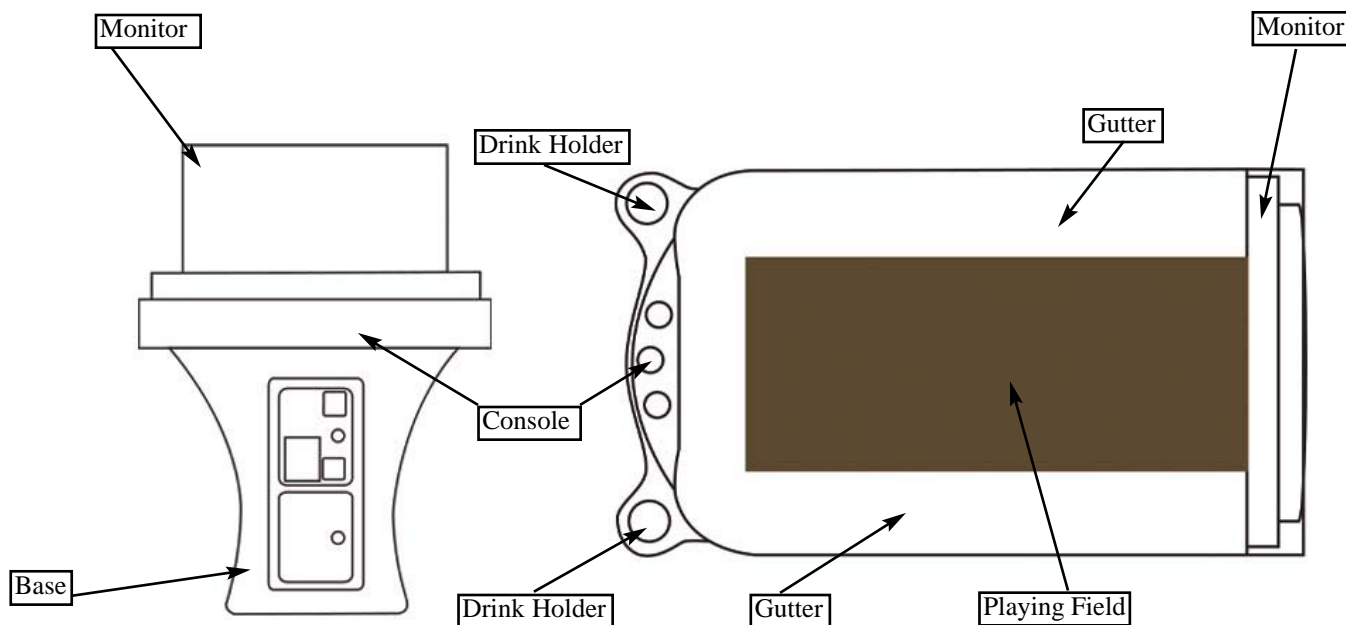

8. Select which player will start first in the match.
9. Once the starting player is chosen, the match begins.
Repeat steps 7 and 8 for the other matches.

At the end of the tournament, the winning player will be awarded with a fanfare and his name being displayed above his opponents.

3.4 Using Jackpot

Jackpot is an optional setting that was designed for promotional use. The players pay a “Jackpot Fee” each time they play a Jackpot game. They are then entered into the promotion and try to be the top three players in the promotion.

A. Turning on Jackpot on the SuperShuffle

This an optional game setting. Only one Jackpot promotion can be running at any one time. The following steps explain how to setup a Jackpot promotion.

1. Press the Service Button to enter the **Setup Menu**.
2. Select **Machine Setup**.
3. Select **Jackpot Setup**.
4. Select **Create New Jackpot**.
5. **Choose Game**.
6. Put in how many credits the **Jackpot Price** will be.
Remember, this is the money that gets put into the pot. The more players that play the bigger the pot. By default, it starts as the same amount for a normal game for one player.
7. Enter in **Starting** and **Ending Date** for the promotion.
8. Figure out the **Split Percentages**. There will only be three winners for the Jackpot. Choose the percentage of the Jackpot 1st, 2nd and 3rd place. The total must equal 100%.
9. Select **Save Jackpot and Return** to save your Jackpot settings and start the promotion.

Once the Jackpot promotion is created, it cannot be edited or turned off.

B. Playing Jackpot

When Jackpot is turned on, the Jackpot logo will appear next to the game selected for the promotion. When players choose to play Jackpot, the Jackpot fee they pay goes into the “pot”. They then play the game as normal.

At the end of the game, a window will prompt them to enter in their names. These names will appear on the Jackpot List. The Jackpot logo will appear next to anyone player on the Top Ten List who is also playing Jackpot.

As soon as the promotion is over, no more scores can be entered.

C. Paying Out

After the Jackpot Promotion is over and you have given the winners their earnings, you need to click the Payout button in the Jackpot menu on the SuperShuffle. This will clear out the current Jackpot settings, start the Jackpot Winners display and get it ready for the next Jackpot Promotion.

The Jackpot Winners attract screen with run for 30 days after the Jackpot is Payed out or until a new Jackpot is payed out.

D. View Jackpot History

This menu shows past Jackpot promotion settings. It displays the start and stop dates, the winners, how much was in the pot, how many people played, how much it cost to enter the promotion and even how much the promotion made for the operator.

Section 4 Operation

4.1 Power Up

Once the machine is assembled and set in place (see Assembly Instructions), connect the power cord to a wall outlet. **Note: The outlet must have an earth ground and be wired for the correct polarity.** The incoming line voltage is not switched and power is immediately applied to the computer

4.2 Main Game Menu

This is the basic menu list on the Super Shuffle that every player can see. Use the Up, Down and Enter buttons to navigate the menus.

A. Bowling

We got the idea for this set of games from the old arcade style puck bowling games.

Classic Bowling: This 1-4 player game essentially plays like traditional bowling you would find in a bowling alley. The point is to be the player with the highest score.

Points are combined from frame to frame. A frame in this game equals a turn for a player. Each player gets up to 2 throws to knock down all the pins each turn.

There are three possible marks you get in bowling. A **Strike**, a **Spare**, and an **Open** (no pins). A player scores points for each pin he knocked down.

A **Strike** is a feat that means you knocked down all the pins with one puck. A Strike earns you 10 points plus the next two pucks thrown. Example: You throw a strike on the first frame. On the next puck you knock down 2 pins. On the third puck thrown, you knock down 7 more pins. This in total will earn you 19 points for the first frame ($10+2+7=19$).

A **Spare** is a feat where you knock down pins for the first puck and then knock down the rest on the second. A Spare earns you ten points plus the next puck thrown. Example: If you get a spare in the first frame and 3 points on your next turn, you earn 13 points for the first frame ($10+3=13$).

An **Open** mark means you knocked down no pins on the puck you threw. This is commonly referred as a “gutter ball”. No pins means no points.

The player with the most points at the end of the game wins.

Classic Bowling PRO: This 1-4 player game plays exactly like the SuperShuffle’s Classic Bowling with one minor difference. The in game puck is smaller. This makes it harder to hit the sensors you want.

Split\Second: Split\Second is a one to six player game of skill and timing. For the most part, Split/Second plays like **Classic Bowling**. You earn points for every pin knocked down except Strikes and Spares.

The twist to this game is the Strikes and Spares. There is a display above the pins that scrolls through point combinations. These are the possible points you can get for Strikes and Spares. A Strike earns the top score while the spare earns the bottom score.

You will need to time your shots so that you get the best points as possible. These points only count for Strikes and Spares.

Split/Second PRO: This 1-4 player game plays exactly like the SuperShuffle’s Split/Second with one minor difference. The in game pucks smaller. This makes it harder to hit the sensors you want.

B. Shuffleboard

These are the games that you might play on a normal shuffleboard.

Knock Off: Players take turns sliding a puck down the playing field. Lasers on the side of the game detect where the puck is in relation to the playing field.

In order to score points, your puck must pass the foul line. If it does not, it is removed (poofed) from play. Only pucks that have completely crossed a point line will get those points.

Example: If your puck lands on the line dividing 3 points from 2 points, that puck is worth 2 points. This is because that puck has not completely crossed the 3 point line.

Only the person whose farthest puck is closest to the end of the table will have their points counted. That person scores points on all his pucks that are ahead of his opponents.

The player who scored points shoots first next round.

Knock Off 11 The first to reach 11 points wins.

Knock Off 15 The first to reach 15 points wins.

You Vs. Super Shuffle: Selecting this menu, you have the choice of playing either Knock Off 11 or Knock Off 15 against the computer.

Crazy Shuffle: This game plays similar to a **Highscore** game except that the playing area is vastly different.

The end of the board has 16 squares with numbers listed between 2 and 9. Each player throws all of his pucks. Each square is worth 100 times the value listed ($2=200$, $9=900$). Hangers are worth double!

The puck needs to make it past the foul line to stay in play. A puck must completely cross into the 100 spot to score any points.

At the end of a players turn, his score is tallied, and all pucks are removed and all the squares are shuffled for the next player. The player with the highest score after 8 rounds wins.

Leader of the Puck: This is a classic count up game. The person with the most points at the end of 8 rounds wins. Unlike the Knock Off games, each player throws all of their pucks on their turn.

First to 21: Play as a normal high score game, except, the first to 21 points wins. Unlike the Knock Off games, each player throws all of their pucks on their turn.

C. League

Play League: This menu will contain a list of leagues for players to choose from. The league is created by the League Coordinator in LeagueLeader.

View League Standings: The players use this menu to view the standings for a specific league. The standings file is generated in LeagueLeader by the League Coordinator.

View League Schedule: The players use this menu to view when and where their next match is and who they play. The league schedules found here will list the matches throughout the whole league. Like all league files, the schedules are generated by the League Coordinator in League Leader.

D. Tournament

The Super Shuffle shuffleboard has a built in tournament mode. It will play between 3 and 8 players. For more info see section 3.4.

E. Return

Selecting this menu will cause the Super Shuffle to enter Attract Mode. Attract Mode is where all the ads and attract screens are displayed and cycled through.

4.3 Setup Mode

To enter the Setup Mode, unlock and open the top coin-door. Press the Service Button. You can also get into the Set Up Menu if you have an Operator Button (see HotButton Setup).

All game options and hardware tests are selectable through software via the Setup Mode. The following are descriptions of the various options available in Setup mode. Use these descriptions as references and follow the instructions on the screen to make changes or view the settings. The up and down buttons are used to navigate menus and the enter button to make selections or changes.

A. Machine Setup Menu

Language Setup: Used to set the display language on the machine.

Time Settings Menu: Used to access current date and time, Happy Hour and Hours of Operation time settings.

Set Time/Date: Used to set the machine's clock and internal calendar.

Happy Hour Time Setup Allows the operator to offer reduced game pricing for a set period each day. To activate this feature, the time period must be set on this screen and Happy Hour set in the Price Settings screen.

Hours of Operation Setup: Setting the location's Hours of Operation will allow the machine to enter sleep mode outside normal business hours. In Sleep Mode the monitor screen will blank out. While in Sleep Mode, inserting a coin or pressing any button will return the machine to Normal Mode.

Coin Slot Assignment: Used to set coins per credit and credits per coin. Adjust the number of coins that have to be inserted to register the number of credits shown or adjust the number of credits that will register for the number of coins shown. Default: 1 coin = 1 credit.

Give This Machine A Name: Used to input a "human friendly" name for each machine.

Free Play: Used to set free play on or off.

Adjust Volume: Allows the operator to adjust the speaker volume.

Collector Settings: By entering in a password in this menu, you will enable a collector to access their reports from the main game screen or attract screen by holding down all 3 buttons at the same time and entering in the correct password.

Attract Setup: The items in this menu allow you to change the settings in the attract mode.

Manage Operator Ads: Displays all operator ads on the board and allows you to delete specific ads. This is good for troubleshooting.

Delete All Operator Ads: Used to delete ALL the graphic files from the machine.

Display Arachnid Ads: This option allows you to turn on and off the attract screens created by Arachnid.

Display Oneliners: This option allows you to turn on and off the quotations that appear in the attract screen.

Display Top Ten List : This option allows you to turn on and off the screens that show the top players for the games.

Blue Light Special Setup: The Blue Light Special option lets you give away free 2 Player Knock Off 11 game while there is no play on the machine. Through this menu you can change the Frequency the Blue Light Special appears in attract mode and how long the Blue Light Special Ad appears.

HotButton Setup: This menu allows you to change board related HotButton settings.

Create HotButton: This menu allows you to create any one of the three HotButtons; Player Button, Collector Button, and Operator Button.

Erase HotButton: This option allows you to erase information off of an individual HotButton.

View HotButton Configuration: This menu displays all the HotButton settings on the shuffleboard.

Maximum Credits: Displays the number of credits a Player Button can hold.

Minimum Credits: Displays the minimum number of credits needed to be purchased before being stored on a Player Button.

Credit Duration: Is the number of days that the credits on a Player Button are good for. A zero in this option means the credits are always good.

Credit ID: This number is an identification number. This number basically means any credits bought on a machine with this ID can be used at another location with the same ID.

Team Fees: This option turns on and off whether HotButton credits can be used for team fees.

Online Promotions: Turns on and off whether this shuffleboard can be used in any HotButton Promotions.

Delete HotButton Configuration: Deletes the HotButton settings from the shuffleboard.

Write Settings to HotButton: Writes the machine configuration to an Operator HotButton.

Read Settings from a HotButton: Loads the settings to the Super Shuffle from an Operator HotButton.

Jackpot Setup:

Create New Jackpot: This menu lets you create a new Jackpot Promotion. See 3.4 for more details.

Edit Jackpot: This menu option lets you make changes to the current Jackpot Promotion. Once the Jackpot promotion is running, this option becomes inaccessible.

Payout: Once the Jackpot promotion is over, this button clears the screen, displays the Jackpot Winners screen, puts results into Jackpot History and lets you make a new Jackpot promotion.

View Jackpot History: Gives you a list of every Jackpot promotion you have done on the Super shuffle. For more info see article 3.4.

Reset Menu:

Reset to Factory Defaults: Resets all options to the original factory setting.

Reset Popularity Counters: Resets all the counters back to zero.

Reset Top Ten Lists: Resets all the Top Ten Lists. This cannot reset a game that is currently in a Jackpot promotion.

Reset Game Settings: Resets Game Round Limits and Price Settings to factory default.

Clear Machine Credits: Clears any accumulated credits from the machine.

Reset League Stats: Clears all stored match statistics.
Warning: Once they have been cleared they cannot be retrieved. Make sure all stats have been collected from the machine prior to using this function!

Delete League Files: Used to delete ALL the league files from the machine.

B. Game Setup Menu

Price Settings: Used to set the number of credits required by each player in normal game mode, league play mode and happy hour mode, for each individual game.

Team Fees: Used to have the machine automatically collect league dues from each team prior to a match. Can be turned "ON" or "OFF" The amount to collect is determined and sent by Arachnid's League Management Software.

Game Round Limits: Used to set round limits for each individual game.

League Round Limits: Turns off and on the round limits for leagues. This uses the round limits set up for casual play.

- League Default for KnockOff 11 & 15 is 99 rounds.
- League Default for Crazy Shuffle is 8 rounds.

Backup Turn Limit: You can change the limit of the "Back Up A Turn" feature of the Super Shuffle.

C. Communications Setup

Connection Type: Choose between LeagueComm (Modem), LeagueLeader (Highspeed) and LeagueLeader (Modem).

Network Settings: In this menu, you can change the settings of the network.

Network Device: This option allows you to choose the device type you are using to communicate with the internet. The Super Shuffle has built in Ethernet capabilities and can be configured to use a WiFi card.

Wireless Settings: If you have installed a Wireless network card, this menu allows you to change the settings of your wireless network.

Auto Scan: Select this to automatically detect wireless access points in your area.

Access Point: This is the name of the wireless access point connected to your Super Shuffle machine.

Encryption Type: This is the security type for your wireless access point. You can choose either WEP (Wired Equivalent Privacy) or WPA (Wi-Fi Protected Access).

Encryption Key: This is the “password” used when connecting to your wireless network. Both access point and Super Shuffle machine must have the same key in order to work.

Use DHCP (Dynamic Host Configuration Protocol): This option, when turned on, will automatically set an IP (Internet Protocol) address for your Super Shuffle Machine. If you turn this option off, you will need to set an IP Address manually.

IP Address: This is the address that your Super Shuffle game uses to access the Internet. If you turned *Use DHCP* off, you will need to set an IP Address manually.

IP Subnet: Provided by your Internet provider.

Gateway: Provided by your Internet provider.

DNS Server 1: Provided by your Internet provider.

DNS Server 2: Provided by your Internet provider.

Modem Settings: If you chose LeagueLeader (modem), this option will be available.

Phone Number: This is the dial up ISP number that you can get from LeagueLeader.

Username: This is where you enter in your ISP login you get from Arachnid.

Password: If you are using LeagueLeader (Modem), the password is the ISP Password you get from Arachnid. If you are using LeagueComm (Modem), make sure you use the same password here as you have programmed in LeagueLeader.

Disable Call Waiting: This will turn off the call waiting feature that may be on the phone system.

Alternate PPP Login: A PPP log in is a protocol used by networks and web providers to communicate with other networks. This option changes how the Super Shuffle talks to the dialup network. Default is **Off**.

LeagueComm Setup: This menu allows you to setup the Super Shuffle to accept calls from your computer.

Phone Number: This is the number that the Super Shuffle uses to call your computer.

Password: This password isn't the one we give you for LeagueLeader. You can make this one up yourself. Make sure that it is the same in the Super Shuffle as well as LeagueLeader.

Incoming Call Window: Used to set the number of rings within the call window and outside the call window, after which the modem will pick up an incoming call. The call window is defined by the beginning time and ending time set on this screen. This feature is contingent on the machine having the correct time set.

LeagueLeader Settings: This menu provides information concerning connecting with LeagueLeader.

Server: This is where LeagueLeader is located on the Internet. It is not adjustable.

FTP Username: This is necessary for communicating with LeagueLeader. This is given to your League Coordinator.

FTP Password: This is necessary for communicating with LeagueLeader. This is given to your League Coordinator.

View Last Update:

View Last Update Log: This displays the last time the Super Shuffle communicated with LeagueLeader.

Clear Last Update Time: Use this option to clear the log of the last time the Super Shuffle communicated with LeagueLeader.

Test Settings: Click this to test your network connections all the way to your LeagueLeader account.

Connect Now: Use this option to communicate automatically.

D. Reports

Game Popularity Counter: Displays a history of machine usage. Shows all games on the machine, the number of times each game was played, the number of credits collected toward each game, and the percentage of times each game was finished.

Coin Slot Report: Displays the number of credits taken in by each of the coin slots individually.

Credits Collection Report: Used by the collector to display credits taken in (since last reset) for game play and league dues.

E. Diagnostics

Hardware Test: This menu has all the programs that will help you troubleshoot the functions of the shuffleboard.

Laser/Sensor Test: This option brings up a screen that will tell you if you are hitting a sensor and how bright the beam is.

iButton Test: This option will test your HotButton and make sure it's working properly.

Reboot: This causes the shuffleboard to shut off then immediately turn back on.

View Boot Log: This report shows the recent history of when the Super Shuffle was turned on and off.

F. Transfer Settings

Write Settings to USB Drive: This option loads the settings of the Super Shuffle to your USB Drive.

Read Settings from a USB Drive: This option takes saved settings on a USB drive and loads them onto the Super Shuffle.

Write Settings to HotButton: Writes the machine configuration to an Operator HotButton.

Read Settings from a HotButton: Loads the settings to the Super Shuffle from an Operator HotButton.

5.4 Operating Conditions

The SuperShuffle can be operated at 115~VAC or 220-240~VAC. There is a switch on the power supply to change between 115 Volts and 220-240 Volts.

Power consumption is 240 Watts at 50/60Hz.

Section 5 Technical Descriptions

Below are technical descriptions of the many parts within the Super Shuffle.

5.1 Monitor

28" Wide LCD Monitor

5.2 Power Supply

ATX Power Supply: 12 VDC, 120 - 264 VAC

5.3 Hardware

PC Board: SATA 3GB/s DDR2 1066

RAM: 1024MB DDR2

Hard Drive: SATA 2.5" 40GB

Section 6 Communications

You can network the Super Shuffle machine with other high-speed equipment in your locations. There are two networking types; Ethernet (wired) or Wireless. You will need a working router for any of these networking options to work.

6.1 Setting up a Wired Network

Setting up a wired network, or ethernet, is fairly straight forward. The Super Shuffle's mainboard has a built in network card. You will need to have a properly set up router first.

1. Run an ethernet cable from the router to the Super Shuffle.
2. Plug the ethernet cable into the ethernet port on the mainboard.
3. Go into the setup mode by pressing the Service Button on the IOB.
4. Select **Communications Settings**.
5. Select **Connection Type**. Choose LeagueLeader (Network).
6. Select **Network Settings**.
7. Select Built-In-Ethernet for the **Network Device**. This will allow you to make changes to the "Use DHCP" option. If you choose not to use DHCP see section 6.3.
8. Select **Back to Network Setup Menu** once finished.

6.2 Setting up a Wireless Network

Setting up a wireless network is setup differently than an wired network. You will need to have a properly set up router first.

1. Unplug the Super Shuffle.
2. Install Kit# 42913-The PCI Bracket
3. Plug in the wireless card on to the motherboard. See A1 (page 15) for our list of recommended Wireless Cards.
4. Secure the PCI Card to the bracket with a screw.
5. Plug in the Super Shuffle.
6. Go into the setup mode by pressing the Service Button on the IOB.
7. Select **Communications Settings**.
8. Select **Connection Type**. Choose LeagueLeader (Network).
9. Select **Network Settings**.
- 10 Select Wireless for the **Network Device**. This will allow you to make changes to the "Use DHCP" option. If you choose not to use DHCP see section 6.3.
- 11.Select **Wireless Network**.
- 12.Choose **Auto Scan**. This will scan your area for any wireless access points.
- 13.Choose the access point you intend to use. Depending on the area, more than one access point may be displayed. Choose your access point.

- 14.Choose your **Encryption Type**. Currently we only support WEP and None. If you chose WEP, make sure to enter in your **Encryption Key**.
- 15.Select **Network Settings**.
16. Select **Back to Network Setup Menu** once finished.

6.3 Manually Setting up your Network

If you choose to manually set up your IP Settings, you will have to input the **IP Address**, **IP Subnet**, **Gateway**, **DNS Server 1**, and **DNS Server 2**. These are provided by the internet provider. If the network in the location isn't yours, contact the bar owner.

6.4 Setting up Dialup

A Dialup connection uses existing analog phone lines to call a local server and log in to the internet. You will need a USB modem in the game. You will also need to connect a phone line to the modem and to the phone system in the location.

1. Select **Communications Settings**.
2. Select **Connection Type**. Choose LeagueLeader (Modem).
3. Select **Modem Settings**.
4. Enter in a Phone Number. This is the number the shuffleboard uses to call into the internet. This number can be found at www.dialupusa.net.
5. Enter in your ISP Username in the **Username** text box.
6. Enter in your ISP Password in the **Password** text box.
7. Exit **Modem Settings**.

Note: Modems designed for Windows operating systems will not work.

6.5 LeagueLeader Settings

LeagueLeader is an online program that is used to create and run leagues on the Super Shuffle. With LeagueLeader you also get automatic software updates for the Super Shuffle. Call Arachnid for more info.

1. Press the service button in the coin door.
2. Select **Communications Settings**.
3. Select **LeagueLeader SETTINGS**.
4. Enter in your **FTP Username**.
5. Enter in your **FTP Password**.
6. Exit LeagueLeader Settings.

6.6 Making a Test Call

Its a good idea to test your connection after you have setup the Super Shuffle communications. While in the communications menu, select **Test Settings**.

The Super Shuffle will test all your settings and connections.

Section 7 Maintenance

There will be times when you will need to manipulate the hardware on the Super Shuffle. This section will explain how.

7.1 Adjusting the Lasers

The lasers are what the Super Shuffle uses to sense when a puck has scored. From time to time, these may be knocked out alignment. Follow the instructions below:

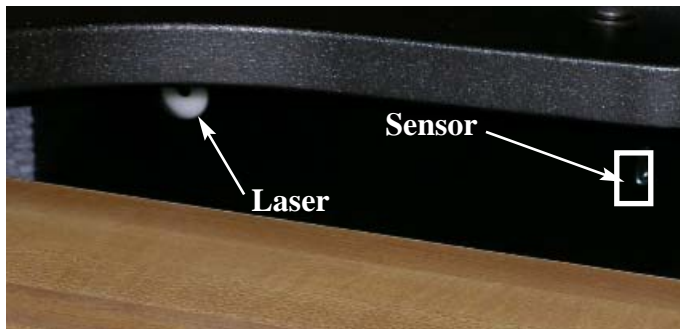

You will need a 1/8" Allen Wrench for this task.

1. Remove the top allen screw and let the laser access plate hang loose.



2. Go to Setup Menu.
3. Select Diagnostics.
4. Select Hardware test.
5. Select Laser/Sensor Test.

- ◆This displays an image of the lasergrid.
- ◆The percentages represent the strength of the lasers.

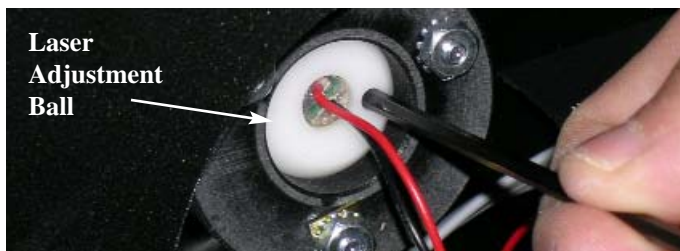

3. Insert the same allen wrench you used in step 1 into the hole provided on the laser adjustment ball.
4. Adjust the lasers. Use the Laser/Sensor Test screen to help you align the lasers. The closer to 100% the better the alignment is. A rating of 100% is dead on.

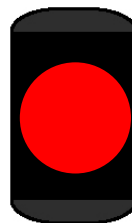

Good Alignment

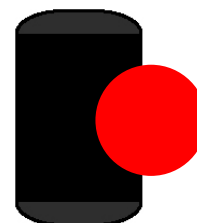

Poor Alignment

5. Once adjusted, close the laser access plate and screw it down.

CAUTION: Do Not Over Tighten The Laser Brackets.

7.2 Replacing the Laser Sockets

The Laser Mount Sockets are what hold the laser "eye" in the Super Shuffle.

1. Unplug the Super Shuffle from the wall.
2. Unscrew the top screw to the laser cover plate.
3. Unplug the green ground wire and the laser cable.
4. Using a 5/16 nut driver, remove the three nuts holding the laser sockets together.
5. Unscrew the ground tab.

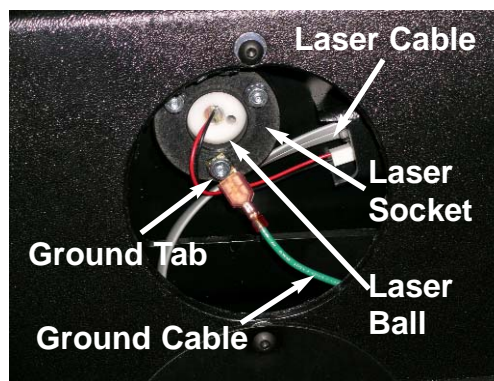

6. Remove the first half of the bracket by pulling it toward you. The laser will come out with it. Take note of how the bracket came out, you will have to put the new one in the same way.

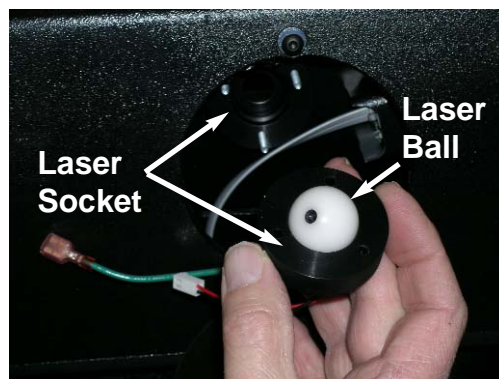

7. Remove the second half of the bracket. Take note of how the bracket came out, you will have to put the new one in the same way.
8. Install the new bracket and laser. **Once the nuts are snug, give each one a quarter turn to tighten. DO NOT OVER TIGHTEN THE BRACKETS. Tightening them more will only damage the bracket.**
9. Plug the Super Shuffle back in and turn on the game.
10. Go into Instructions from the main menu. This will turn the lasers on for three (3) minutes.
11. Adjust the lasers as needed.

7.3 Replacing the Sensor Module

The Sensor Module of the Super Shuffle includes the laser and the sensor.

1. Unplug the Super Shuffle from the wall.
2. Remove the top allen screw, using the 1/8 allen wrench (3mm), from the Sensor adjustment plate.

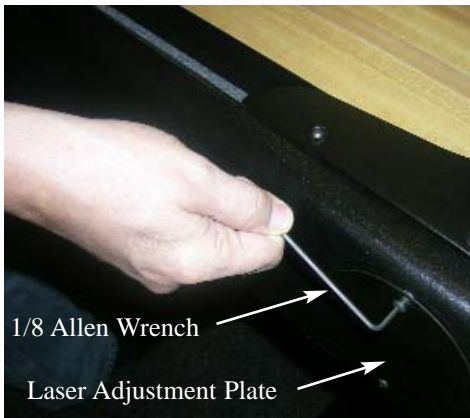

3. Disconnect the green ground wire from the laser.
4. Disconnect the communication cable from the sensor port.

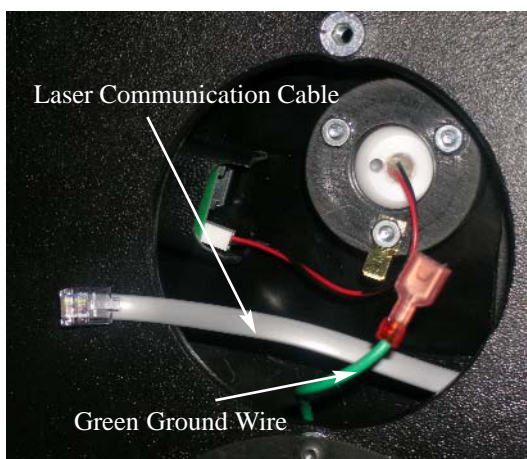

5. Unscrew the two screws, using a 5/32" or 4(mm) allen wrench, from the top of the sensor module.
6. Remove the old sensor module.
 - a. The module will be a snug fit.
 - b. Gently wiggle the module back and forth to loosen it.

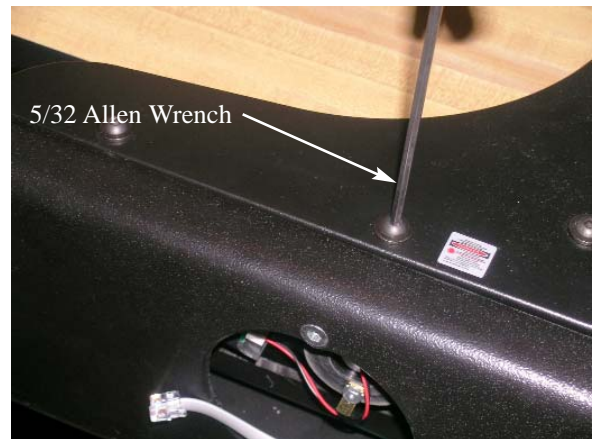

7. Insert the new module. There are alignment pins in the top of the sensor module. Use those to place the sensor module in the correct position.
8. Replace and tighten the screws you removed in step 5.
9. Attach the green ground wire to the laser.
10. Plug in the communication cable into the laser port.

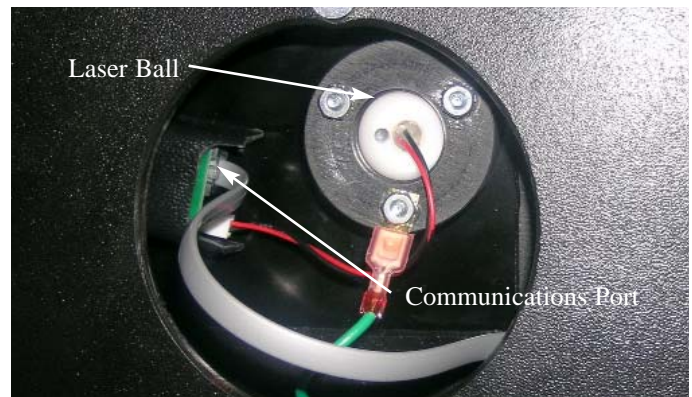

11. Repeat steps 2-10 for the opposite side if necessary.
12. Plug the Super Shuffle back into the wall.
13. Align the lasers so that the game will function properly.
14. Secure the laser adjustment plate.

7.4 Opening the Playing Surface

In order to change components, add a modem, network card or get into the **Setup Mode**, you will need to open the playing surface.

1. Use your key and unlock the playing surface in the front. After unlocking, remove the key.
2. Put both hands to the side of the playing surface. You should feel a hand hold on each side.
3. Carefully slide back the playing surface about an inch.
4. Lift up the playing surface and slide toward you. The Super Shuffle cabinet has notches that allow you to rest the playing surface on so that you don't have to remove it completely from the game.

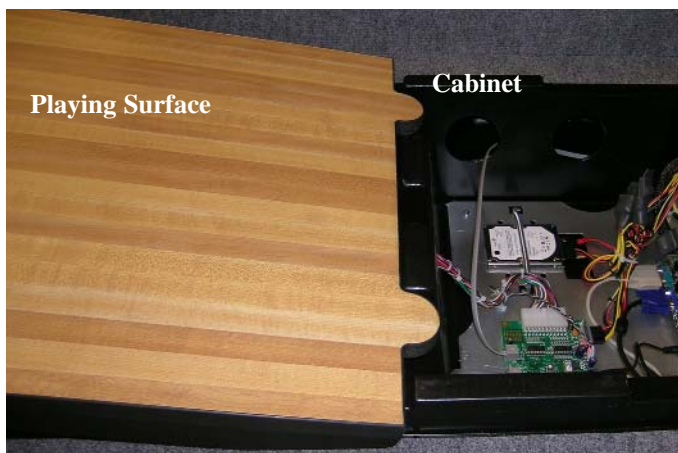

7.5 Installing a Dollar Bill Acceptor

The Super Shuffle comes Bill Acceptor ready. Simply plug the Bill Acceptor wires into the coindoor harness and plug in the power cable into the Distribution Box.



7.6 Puck Maintenance

The Super Shuffle puck shouldn't need much maintenance. There are just a few considerations:

- ♦ **Do Not Oil the Bearing.** The Bearing does not need lubricant.
- ♦ Keep bearing free from debris. Use rubbing alcohol and compressed air to clean the bearing.
- ♦ Keep the bearing dry.

7.7 Playing Surface Maintenance

The Super Shuffle playing surface shouldn't need much maintenance. Unlike other shuffleboard machines, you won't need to wax, polish or put any kind of lubricating material on the playing surface.

It will, however, need to be kept clear of any messes. Use any multi purpose cleaner and a paper towel to clean the playing surface.

Section 8 Collector Menu

The Collector Menu is a quick way to access several operator functions of the Super Shuffle. From this menu you will be able to force a call, access the setup menu and view collector reports.

8.1 Activating the Collector Menu

Before the Service Menu can be used, you will need to activate it in the setup mode.

1. Enter Setup Mode (see 7.3 for more info).
2. Select **Machine Setup**.
3. Select **Collector Settings**.
4. Select **Enter Collector Password**.
5. Put in a password that you can remember. Make sure to tell the rest of the collectors.
6. Select **Save**.

Once the password is saved you can exit setup mode.

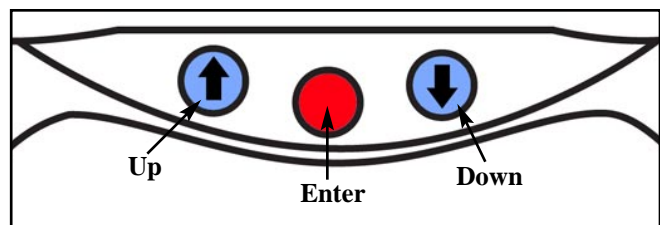

8.2 Accessing the Collector Menu

Accessing the Service Menu is pretty easy. While in any screen in Game Mode, press and hold the three buttons on the console for three (3) seconds.

You will be prompted to enter in the Collector Password (see 8.1). After the password is entered, select **Save**. This will grant you access to the Service Menu.

8.3 Using the Reports

The Game Popularity Counters, Coin Slot Report, and Credit Collection Report can all be accessed from this menu making it simple for the collector to get the information he needs. Information on these reports can be found on page 6.

Section 9 Parts List

The numbers listed are Arachnid part numbers. Please use the Arachnid numbers when placing an order. Some descriptions are followed by a number in parentheses. This number is the quantity used in that assembly.

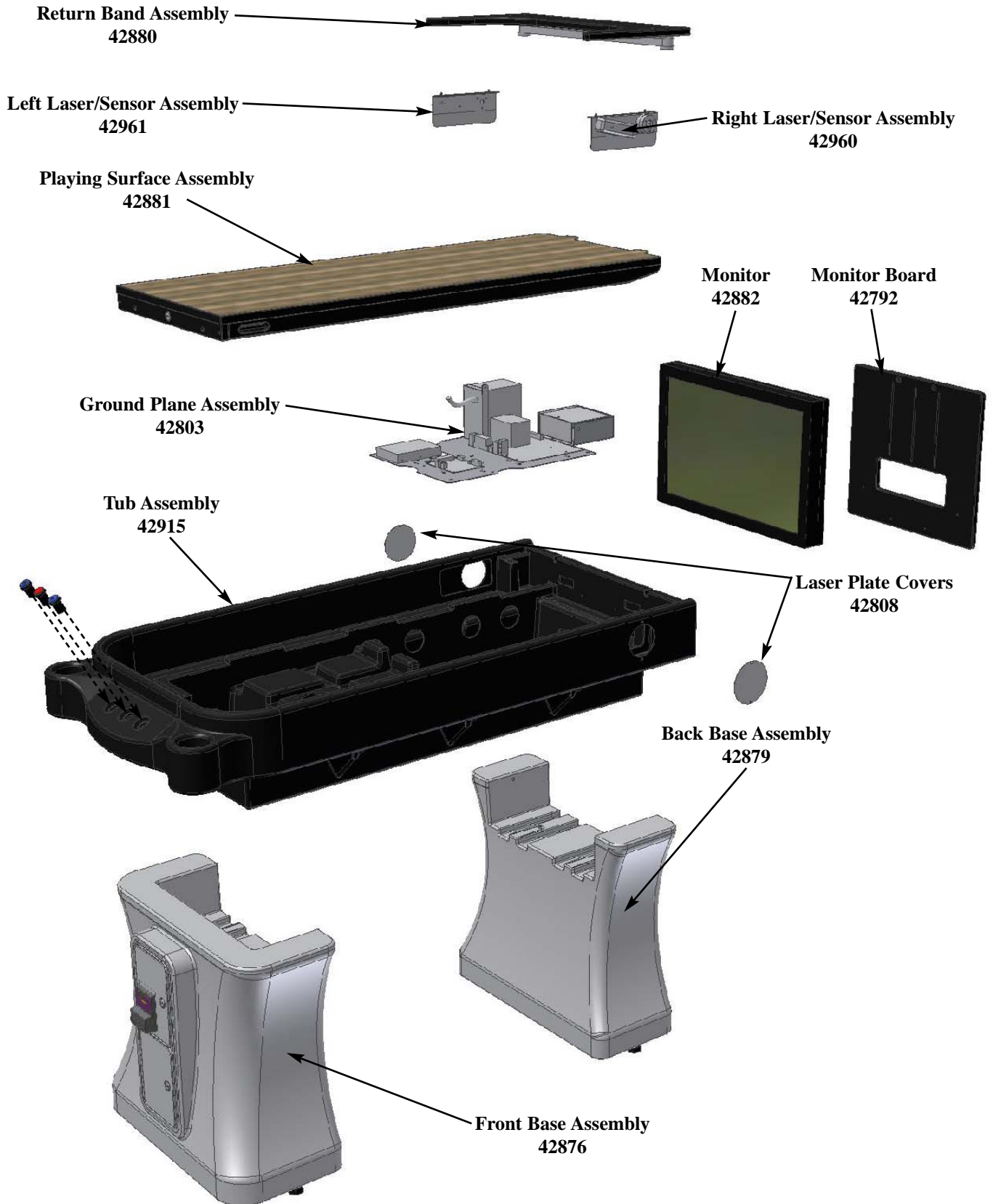

9.1 Super Shuffle - 42798

This is a list of the subassemblies and their part numbers. What will follow after this section is a broken down parts list of those sub assemblies.

| Part # | Subassembly | Section |
|--------|-----------------------------|---------|
| 42882 | Monitor | 9.1 |
| 42792 | Monitor Board | 9.1 |
| 42880 | Return Band Assembly | 9.2 |
| 42808 | Laser Adjustment Cover | 9.1 |
| 42961 | Left Laser/Sensor Assembly | 9.3 |
| 42960 | Right Laser/Sensor Assembly | 9.4 |
| 42881 | Playing Surface Assembly | 9.5 |
| 42803 | Ground Plane Assembly | 9.6 |
| 42915 | Tub Assembly | 9.7 |
| 42876 | Front Base Assembly | 9.8 |
| 42879 | Back Base Assembly | 9.9 |

9.2 Return Band Assembly - 42880

| Part # | Description |
|--------|--------------------------------|
| 42765 | Wooden Support for Return Band |
| 42767 | Band Mount Post (2) |
| 42766 | Return Band |

9.3 Left Laser/Sensor Assembly - 42961

| Part # | Description |
|--------|------------------------------|
| 42809 | Cover Plate |
| 42778 | Socket Laser Mount |
| 42825 | Left Sensor Mounting Bracket |
| 42963 | Laser Ball Assembly |
| 42873 | Sensor Assembly |

9.4 Right Laser/Sensor Assembly - 42960

| Part # | Description |
|--------|-------------------------------|
| 42809 | Cover Plate |
| 42778 | Socket Laser Mount |
| 42824 | Right Sensor Mounting Bracket |
| 42963 | Laser Ball Assembly |
| 42873 | Sensor Assembly |

9.5 Playing Surface Assembly - 42881

| Part # | Description |
|--------|-----------------|
| 41570 | Lock |
| 42800 | Playing Surface |

9.6 Ground Plane Assembly - 42803

| Part # | Description |
|--------|----------------------------------|
| 42828 | Motherboard w/Processor and RAM |
| 42943 | Programmed Hard Drive |
| 42688 | IOB |
| 42746 | ATX Power Supply |
| 39370 | 5x20mm Chassis Mount Fuse Holder |
| 42023 | 3.15A Slo-Blo 250V Fuse |

9.7 Tub Assembly - 42915

| Part # | Description |
|--------|-----------------------------|
| 19131 | Red Push Button |
| 39753 | Blue Push Button |
| 34811 | 14V Incandescent Lamp GE658 |
| 42763 | Black Molding |
| 42771 | Right Side Grey Carpet |
| 42770 | Left Side Grey Carpet |
| 42773 | Bottom Right Grey Carpet |
| 42772 | Bottom Left Grey Carpet |
| 42822 | Right Post Grey Carpet |
| 42823 | Left Post Grey Carpet |
| 42717 | Upper Cabinet" Tub" |

9.8 Front Base Assembly - 42876

| Part # | Description |
|--------|--------------------|
| 42115 | Hot Button Reader |
| 41883 | Coin Door |
| 42416 | Leveler (2) |
| 42718 | Front Base Cabinet |

9.9 Back Base Assembly - 42879

| Part # | Description |
|--------|-------------------|
| 42416 | Leveler (2) |
| 42719 | Rear Base Cabinet |

Section 9: Troubleshooting

| .Problem | Possible Cause | Solution |
|--------------------------------------------------------------------------------------------------------------------|---------------------------------------------------------------------------------------------------------------------------------------------------------------------------------------------------------------------------------------------------------------|-------------------------------------------------------------------------------------------------------------------------------------------------------------------------------------------------------------------------------------------------------------------------------------|
| Unable to Communicate with IOB | a. Parallel cable is unplugged either from the IOB or the Motherboard. | a. Check connections. Reattach cable if necessary. |
| Lasers are blocked <i>Left Laser Blocked</i> <i>Right Laser Blocked</i> <i>Both Lasers Blocked</i> | a. Laser is blocked. b. Lasers unaligned. c. Laser light is dim. | a. Remove blockage. If none is evident check the laser and sensor ports. Clean the sensor and laser. b. See 7.1 for instructions. c. Check connections for laser. Make sure the laser is plugged in to the IOB. If it is it could be a bad laser. Replace laser. |
| No Video | a. VGA Cable is not attached. b. The power cable is not attached. c. The external powerswitch on the back of the Super Shuffle is switched to off. d. The monitor is not plugged into the junction box in the rear of the Super Shuffle. | a. Check the connections at monitor and the motherboard. b. Check the connections at monitor and the motherboard. c. Flip the external power switch on the back side of the Super Shuffle to ON . d. Make sure all connections are in place and secure. |
| The Dollar Bill Acceptor is not Functioning | a. The powercord to the Dollar Bill Acceptor is not plugged in. b. The Dollar Bill Acceptor is not configured properly. | a. Plug in the Dollar Bill Acceptor powercord into the powersupply underneath the playing field. See Section 7.4 . b. Configure the Dollar Bill Acceptor using it's manual. |

A1 Recommended Wireless PCI Cards

| Card Name/Model | Documented Transmission Distance | Protocol and Standards |
|---------------------|----------------------------------|----------------------------------------------|
| iMicro NT-PCI54M | Up to 200m Indoor | IEEE 802.11g IEE 802.11b |
| SABRENT PCI-G802 | Up to 100m Indoor | IEEE 802.11g IEE 802.11b CSMA/CA w/ACK |
| EdiMAX EW-7128G | Up to 50m Indoor | IEEE 802.11g IEE 802.11b |
| TRENDnet TEW423PI/A | 35-100m Indoor | IEEE 802.11g IEE 802.11b |
| EnGenius EPI-3601S | Unknown | IEEE 802.11g IEE 802.11b |
| Zonet ZEW 1605 | Up to 100m Indoor | IEEE 802.11g IEE 802.11b |
| HiRO H50170 | Up to 50m Indoor | IEEE 802.11g IEE 802.11b |
| Rosewill RNX-G300EX | Up to 80m Indoor | IEEE 802.11g IEE 802.11b |

A2 Recommended Modem

| Model Name | Type |
|-----------------|------|
| Zoom 3095 US | USB |
| USRobotics 5637 | USB |



www.bullshooter.com | www.arachnidinc.com | 800.435.8319 815.654.0212 | Fax 815.654.0447